



38

L version

Owner's Manual

Contents

Introduction	7
Notes on reading this manual	9
1 Technical specifications	11
1.1 Construction	11
1.2 General dimensions	11
1.3 Engine	11
1.4 Capacities	12
1.5 Sails	13
2 Design categories and displacement	15
2.1 Design categories	17
3 Stability and buoyancy	19
3.1 Stability information	19
3.2 Access to the boat	21
4 Manoeuvrability	23
4.1 Visibility from the steering station	23
4.1.1 Navigation lights / Deck searchlight	24
5 Rigging and sails	25
5.1 Rigging diagram	25
5.2 Standing rigging	27
5.3 Running rigging	27
5.4 Sails	28
5.5 Deck fittings	29
5.6 Winches	29
5.7 Genoa furler	31
5.8 Single line furler	31
6 Safety	33
6.1 Preventing man overboard situations and means of reboarding	33
6.1.1 Prevention of man overboard	33
6.2 Storing the liferaft	35

Contents

6.3	Securing moveable items	36
6.4	Emergency systems in case of steering gear failure	37
6.5	Information on lightning-related risks	38
6.6	Informations in case of grounding of impact	38
7	Information relating to fire risks and risks of explosion	39
7.1	Propulsion engines and other fuel-burning equipment	39
7.2	Electrical system	40
7.3	Gas system	40
7.4	Fire fighting and prevention equipment	41
7.4.1	Fire-fighting equipment	41
7.4.2	Smoke alarm	44
7.4.3	Extinguisher access port (Engine compartment)	46
7.5	Emergency exits in case of fire	47
7.6	In the event of capsizing	47
8	Electrical system	49
8.1	General information about the electrical system	49
8.2	DC installation (12V or 24V)	50
8.2.1	Battery use and distribution	50
8.2.2	Battery switches	51
8.2.3	Power distributor	51
8.2.4	Battery charger	51
8.2.5	Diagram of layout - DC electrical circuit	52
8.2.6	Installation of the hull wiring loom - DC electrical circuit	53
8.2.7	Installation of roof wiring bundle - DC electrical circuit	55
8.2.8	Electrical panel	56
8.2.9	Fuses	58
8.3	AC system (110V or 220V)	58
8.3.1	General points	58
8.3.2	AC shore socket	60
8.3.3	AC source selectors	60
8.3.4	Diagram of layout – AC electrical system	61
8.3.5	DC/AC converter	63
8.4	Protection against electrolysis / Earthing plate	65
8.4.1	Anodes	65
8.4.2	Earthing plates	66
9	Liquefied Petroleum Gas (LPG) System	67
9.1	General points	67

9.2	Operation of the LPG system	68
9.3	Verification of the LPG system	69
10	Water systems	73
10.1	General points	73
10.2	Information on flooding risks and boat stability	73
10.2.1	Hull openings	73
10.2.2	Drainage system	74
10.3	Fresh water filling system	78
10.4	Fresh water distribution system	79
10.5	Water unit	80
10.6	Blackwater system (Toilet)	80
10.7	Waste water system	85
11	Engine	87
11.1	Information relating to fire risks and risks of explosion	87
11.2	Danger from moving mechanical parts	88
11.3	General points	88
11.4	Engine installation	89
11.5	Starting the engine	90
11.6	Propeller	90
11.7	Fuel-burning equipment for purposes other than propulsion (Generator)	91
11.7.1	Generator	91
12	Steering system	93
12.1	General points	93
12.2	Diagram of layout	94
13	Deck fittings	95
13.1	Equipment	95
13.1.1	Davits	95
13.1.2	Anchoring, mooring, towing	96
13.2	Anchoring, mooring, towing	96
13.2.1	Anchor points	96
13.2.2	Mooring	98
13.2.3	Towing	98
13.3	Electric windlass	99
13.4	Tender	99

Contents

14 Handling and transport	101
14.1 Position of straps	101
14.2 Lifting	101
14.3 Launching and retrieving	102
14.4 Stepping and unstepping the mast	102
14.5 Winterisation	102
15 Environment	103
Appendix	105
Label key	105

Introduction

Your dealer will be able to advise you and assist you with how to operate and maintain your yacht.

The first time you use your boat a high level of skill and attention will be required. The proper functioning of all equipment will depend on the initial set-up being carried out correctly. For this reason the first launch must be carried out under your dealer's supervision.

Read this Owner's Manual carefully and take time to get to know your boat before you use it.

The better you know your vessel, the better your experience will be when sailing it.



For each piece of equipment on your boat, please read the instruction manuals provided by the manufacturer.

Notes

- Keep this manual somewhere safe and pass it on to the new owner should you sell your boat.
- You are advised to keep any user's guides supplied by the manufacturers of any equipment for your boat (accessories, etc.), together with your manual.

Introduction

- This manual is written to help you enjoy your boat in safety. It contains details of the boat and of all the equipment provided and installed on your boat, as well as instructions for its use. Read it carefully and get to know your boat properly before using it.
- This owner's manual is not in any way a navigation or mariner's training manual. If this is your first boat or if you have changed to a type of boat with which you are not familiar, make sure that you learn how to use it and manoeuvre safely and with ease before taking the helm alone. Your dealer, national sailing or motorboat association, or yacht club will be very happy to tell you about navigation schools or qualified instructors in your area.
- Make sure that the wind and sea conditions forecast are appropriate for the design category of your boat and that you and your crew are capable of manoeuvring the boat in these conditions.
- Even with a well-adapted boat, the wind and sea conditions which correspond to the design categories A,B and C range from storm force winds for category A to severe storm conditions at the upper end of category C, and could put the boat at risk from very large waves and strong gusts. These are dangerous conditions in which only an experienced, fit and well-trained crew, manoeuvring a well-maintained boat, will be able to navigate with sufficient skill.
- This owner's manual is not intended as a detailed maintenance or repairs manual. Should any problems arise please contact your dealer. If a maintenance manual is provided, please use it.
- Always use the services of an experienced professional for the maintenance of your boat, for fitting accessories and for any modifications. Any alterations which may affect the safety specifications of the boat must be assessed, carried out and recorded by persons qualified to do so. The boat manufacturer cannot be held responsible for any modifications not approved by them.
- Some countries require you to hold a Certificate of Competency or other such qualifications, or there may be other specific regulations in force.
- Always maintain your boat well and make note of any deterioration due to wear and tear or to heavy or inappropriate use.
- Any boat – no matter how well-built – could suffer serious damage if used recklessly. This kind of use is highly unsafe. Always adjust the speed and heading of your boat according to the sea conditions.
- If your boat is equipped with a life-raft, read the instruction manual carefully. The crew must have all safety gear available onboard (lifejackets, harnesses etc.), and this must be appropriate for the type of boat and for the weather conditions. In some countries it is mandatory to have this safety equipment onboard. The crew must be fully familiarised with the use of the safety gear and with emergency manoeuvres (man overboard procedures, towing another vessel etc). Sailing schools and clubs regularly run training sessions for these skills.
- All persons should wear appropriate personal flotation devices (life jackets/ buoyancy aids) when they are on deck. Be advised that in some countries it is mandatory to wear a flotation device which meets the national regulations at all times.

Notes on reading this manual

The various symbols used throughout the manual for crucial safety information are as follows:



Danger

Indicates an imminent danger situation which, if not avoided, will lead to death or serious injury.



Caution

Indicates a potentially dangerous situation which, if not avoided, may lead to minor or moderate injury.



Warning

Indicates a potentially dangerous situation which, if not avoided, may lead to death or serious injury.

Note

Indicates information considered to be important but not linked to a danger, for example concerning damage to property.

- While some of the information and illustrations in this manual may show details which are slightly different from those found on your boat, the key information remains the same. Future versions of this manual will show any possible modifications as required.
- Due to the constant desire to improve the products, SPBI S.A. reserves the right to make any changes considered necessary to the design or to the equipment.
The specifications and information given are not contractual and may be modified without prior notice or updates.



- This owner's manual is written in several languages. French is the authentic reference language.
- This owner's manual was written and formatted by SPBI S.A.. Any reproduction of this manual, direct or indirect, provisional or permanent, by whatever means, whether in whole or in part, as well as any modification by third parties for commercial reasons, is forbidden.

Technical specifications

1.1 Construction

- Model Lagoon 38
- Architect Van Peteghem Lauriot-Prévost / Nauta Design
- Builder SPBI S.A
- Principal means of propulsion Sail

1.2 General dimensions

- L.O.A (L_{max})* 13,34m
(Including removable parts that can be dismantled (bow roller, pulpit, bowsprit), without affecting the structure of the boat)
- Hull length (L_h)* 12,09m
(Excluding: removable parts that can be dismantled without affecting the structure of the boat)
- Overall width (B_{max})* 6,65m
(Including: removable parts that can be dismantled without affecting the structure of the boat)
- Beam (B_h)* 6,65m
(Excluding: removable parts that can be dismantled without affecting the structure of the boat)
- Air draft – Empty vessel (including the VHF antenna option) 19,78m
- Draught – Boat fully laden 1,26m

1.3 Engine

- Nominal maximum propulsion power (at the propeller output) 2 x 20,3Kw
- Maximum recommended engine size 2 x 157kg

1.4 Capacities

- Fuel capacity
 - Tank 1 (*) 200L
 - Tank 2 (*) 200L
- Fresh water capacity
 - Tank 1 (*) 300L
 - Tank 2 (*) 206L
- Blackwater capacity (Toilet)
 - Tank 1 (*) 80L
 - Tank 2 (*) 80L

It may not be possible to use these capacities fully depending on the trim and load of the boat. It is recommended that you keep a reserve of 20% in the fuel tanks.

* Definition

Refer to the corresponding chapter to locate the position of the tank (each tank number corresponds to its position on board).

Total mass of liquid contents of fixed tanks when full 1 010kg

Notes

- The density of a liquid can vary according to its temperature and quality.
- The volume masses chosen are:
 - 0,86kg/L for diesel fuel,
 - 1kg/L for water.

1.5 Sails

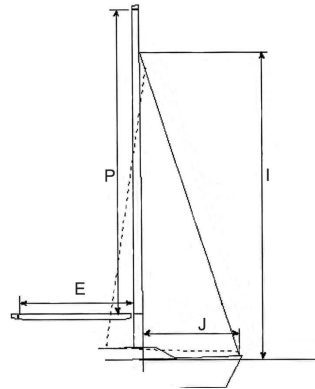

I. Distance between deck and highest genoa halyard sheave.....	13,19m
J. Distance between the fore of the mast and the bow fitting on the deck	4,61m
P. Length of the mainsail luff.....	13,97m
E. Length of the mainsail foot.....	5,5m

- Square top mainsail 56m²
- Jib 23m²
- Code 0 54m²

- Planned sail area* 73m²

*** Definition**

designated by (AS) and calculated as the sum of the projected surfaces in profile of all sails that can be established when the vessel is close hauling, on the booms, horns, bowsprits or other spars, and the surface of fore triangle(s) to the foremost forestay, fixed permanently during operation of the vessel with the mast bearing the established sails, without overlap, assuming that the jackstays and leeches are straight lines.

The surface of the spars is not included in the projected calculation sail plan area, with the exception of the wing-masts.

Design categories and displacement

Design category	A	B	C	D
Light displacement (<i>Mlc</i>)*	10 280kg			
Recommended maximum load (<i>MI</i>)*	3 958kg	4 238kg	4 358kg	4 618kg
Displacement with maximum load (<i>Mldc</i>)*	14 238kg	14 518kg	14 638kg	14 898kg

* Definition

Mlc: *Mass of the boat in light craft condition*

includes the weight of the boat in the standard ready-to-navigate configuration, keel, standard equipment, engine(s) and sails (if the boat is a sailing boat).

MI: *Maximum load*

Load that the boat is expected to support in addition to the light ship condition, including:

- The weight of all people on board (maximum of 75 kg per person);
- Personal effects and supplies;
- provisions and cargo (where applicable), dry goods, consumable liquids;
- the content of all permanently installed tanks filled to 95% of the maximum capacity, including fuel, drinking water, black and grey water, lubrication and hydraulic oil, bait and/or fish tanks, plus ballast water at 100% of the tanks' capacity;
- the consumable liquids in the removable tanks (drinking water, fuel) filled to 95% of their maximum capacity;
- the tender or other craft expected to be transported onboard, and any outboard motor for said craft;
- life raft(s) in addition to the minimum number required for the essential safety equipment;
- non-edible foodstuffs and equipment normally transported onboard and not included in the list of standard manufacturer's equipment, for example interior movable equipment, tools, spare parts and the anchors.

Mldc: *Mass of the boat in Maximum Load Condition*

Includes light ship mass (*Mlc*) + maximum load (*MI*).

2 Design categories and displacement

Design category	A	B	C	D
Maximum number of people on board (CL *)	8	12	16	20
Maximum number of people on the flying bridge	8	8	8	8
Maximum load on the manufacturer's plate (Mmbp *)	1 200kg	1 480kg	1 600kg	1 860kg

Remark: It is normal for the weight shown on the manufacturer's plate (boat with empty tanks) and the maximum weight indicated in the owner's manual (boat with full tanks) to be different.

* Definition

CL: Crew Limit

Recommended maximum number of people on board when the boat is underway.

Mmbp: Maximum mass on builder's plate

Maximum load on the manufacturer's plate: the maximum load recommended by the manufacturer and shown on the manufacturer's plate EXCLUDES the fixed tanks when they are full (fuel, freshwater, greywater, black water).

Some information is shown on the manufacturer's plate fixed to the boat. Explanations of the information given can be found in the relevant chapters of this manual.

Name plate

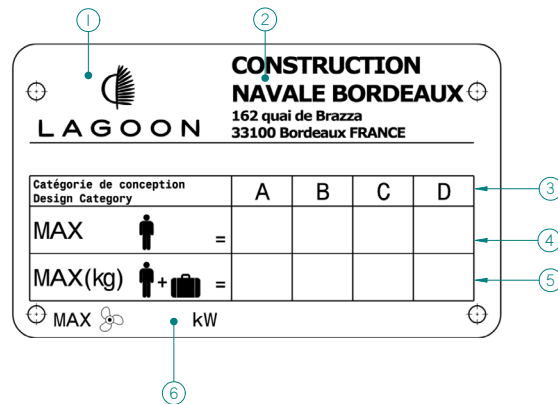

1. Brand name
2. Shipyard of construction
3. Design category
4. Maximum number of people onboard
5. Maximum load on the manufacturer's plate, in kg (*Mmbp* *)
6. Maximum power of engine(s)

2.1 Design categories

The boat has been designed for personal, private use. It can also be used commercially, for charters with or without crew. However, the boat has not been designed as a "workboat" as defined by standard ISO 12215.

Category A

A boat which has been assigned design category A is deemed to have been designed for sailing with wind speeds below Beaufort force 10 and the associated significant wave heights.

Category B

A boat which has been assigned design category B is deemed to have been designed for sailing with wind speeds of less than or equal to Beaufort force 8 and the associated significant wave heights of up to 4 m

Category C

A boat which has been assigned the design category C is considered to have been designed for sailing in strong winds typically less than or equal to Beaufort 6 and the associated waves of a significant height of up to 2 m.

Notes

The life rafts are not included as essential safety equipment for categories C and D.

Notes

These conditions may typically be encountered during long voyages, for example across oceans, but they can also occur close to the shore when the area is not protected from the wind and waves for several hundred nautical miles. Depending on atmospheric conditions, wind speeds may reach gusts of up to 32 m/s.

Notes

These conditions may typically be encountered when sailing a sufficient distance off shore but may also occur close to shore when shelter may not be immediately available. These conditions may also be encountered on lakes of sufficient size to generate the aforementioned wave heights. Depending on atmospheric conditions, wind speeds may reach gusts of up to 27 m/s.

Notes

These conditions may typically be encountered in exposed inland waters, estuaries and coastal zones in moderate weather. Depending on atmospheric conditions, wind speeds may reach gusts of up to 27 m/s.

2 Design categories and displacement

Category D

A boat which has been assigned the design category D is considered to have been designed for sailing in strong winds typically less than or equal to Beaufort force 4 and the associated significant wave heights of up to 0,3 m and occasional waves of up to 0,5 m.

Notes

These conditions may be encountered in sheltered inland waters and coastal areas in fine weather. Depending on atmospheric conditions, wind speeds may reach gusts of up to 12 m/s.

Stability and buoyancy

3.1 Stability information

- Fully laden displacement was used to evaluate the stability and buoyancy of the boat. The value of this displacement can be found in the "Technical specifications" paragraph at the beginning of this manual.
- Any changes in the distribution of loads onboard (for example by adding a raised structure for fishing, fitting a radar or in-mast furling, changing the engine etc.) can significantly affect the boat's stability, trim and performance;
- It is important to keep water in the bilges to a minimum;
- Stability is affected by the addition of weight above the main deck;
- In heavy weather it is important to close all the hatches, lockers and doors to minimise the risk of water pouring in;
- The boat's stability can be reduced when towing a boat or when using a davit or boom to lift a heavy load;
- Breaking waves are a serious threat to stability.



All of the watertight hatches must remain closed when at sea.



The skipper is responsible for ensuring that the normal operating mode is maintained. This means that the boat's speed is appropriate for the sea state and it is used with a sense of "good seamanship".

3 Stability and buoyancy

- This boat is likely to capsize or be overrun if it is over-canvassed. In these circumstances, it may then sink. The sail plan should be adjusted according to wind and sea conditions and it is important to be particularly vigilant in case of gusty winds or squalls.
- This vessel is likely to capsize and remain inverted if she carries an excessive sail surface. The sail plan should be reduced if wind exceeds 15 knots..

The following openings are marked "MUST BE CLOSED WHEN UNDER WAY"; ensure that this warning is observed. "Under way" means the boat is not anchored or moored to the ground, nor is it aground.



- The boat may capsize if carrying too much sail.
- It is important to take additional precautions in the event of strong winds, rough seas or breaking waves.

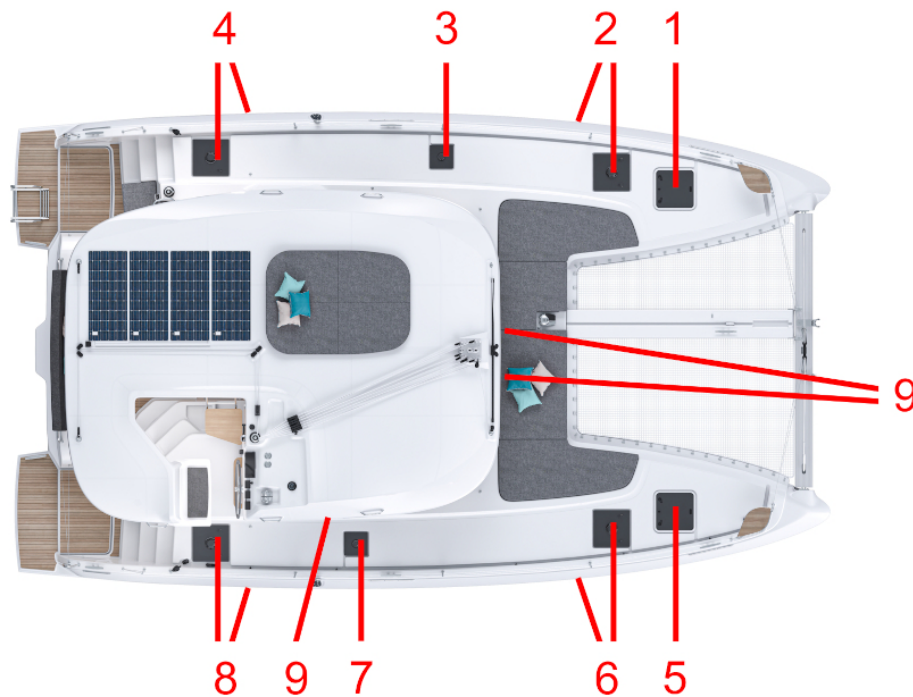

1. Port side skipper cabin
2. Port forward cabin
3. Port headroom
4. Port aft cabin / Aft port head compartment
5. Starboard skipper cabin
6. Starboard forward cabin
7. Starboard headroom
8. Starboard aft cabin
9. Saloon

3.2 Access to the boat



- It is essential that both the cockpit and the engine compartment are kept closed when at sea.
- When at sea close the guardrail side-opening or openings.
- Slamming an access hatch may cause injury : always close the hatch gently and carefully.
- Do not allow children to open or close the hatches unsupervised.
- Do not use the skipper cabin whilst under way.
- It is forbidden to climb onto the roof while under way.



- It is essential that the access doors to the saloon are kept closed when at sea.
- Close the deck hatches and portholes before each trip.
- Close all access doors and hatches in heavy weather or when the sea is rough.

Advice / Recommendation

When under way, keep hull valves and fillers in the closed position to minimise the risk of flooding.

Manoeuvrability

4.1 Visibility from the steering station

- The helmsman's view from the steering station may be obstructed by one or more of the following variable conditions:
 1. Load and load distribution;
 2. Speed;
 3. Sea conditions;
 4. Reduced visibility caused by rain, darkness or fog;
 5. Reduced visibility caused by changing or hauling up sails (all sails except mainsail);
 6. Interior lighting;
 7. Position of the covers or curtains;
 8. Persons or mobile equipment located in the helmsman's field of view.
- The international rules and regulations for avoiding collisions at sea (Col Reg / RIPAM) require a full and constant lookout as well as observance of the rules of right-of-way. Observance of these rules is essential.



When the helm area has multiple steering device, precautions must be taken when moving from one steering device to another.

4 Manoeuvrability

4.1.1 Navigation lights / Deck searchlight

- The navigation lights are positioned on the stems and on the aft of the roof. The lights are LEDs.
- The masthead light is placed on the mast, below the spreaders. This is an LED light with a power of 2,5 W.

Control

Location: Starboard companionway

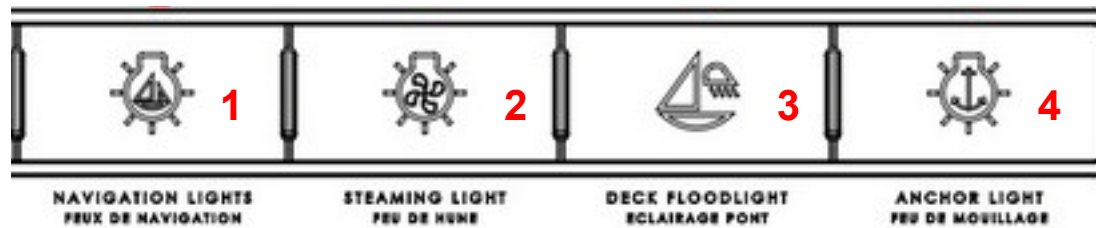

1. Navigation lights
2. Steaming light
3. Deck light
4. 360° light

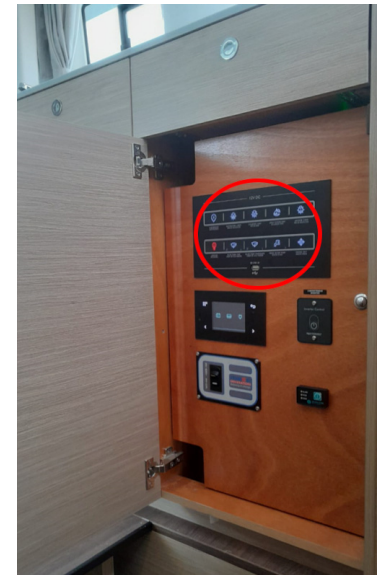

Rigging and sails

5.1 Rigging diagram

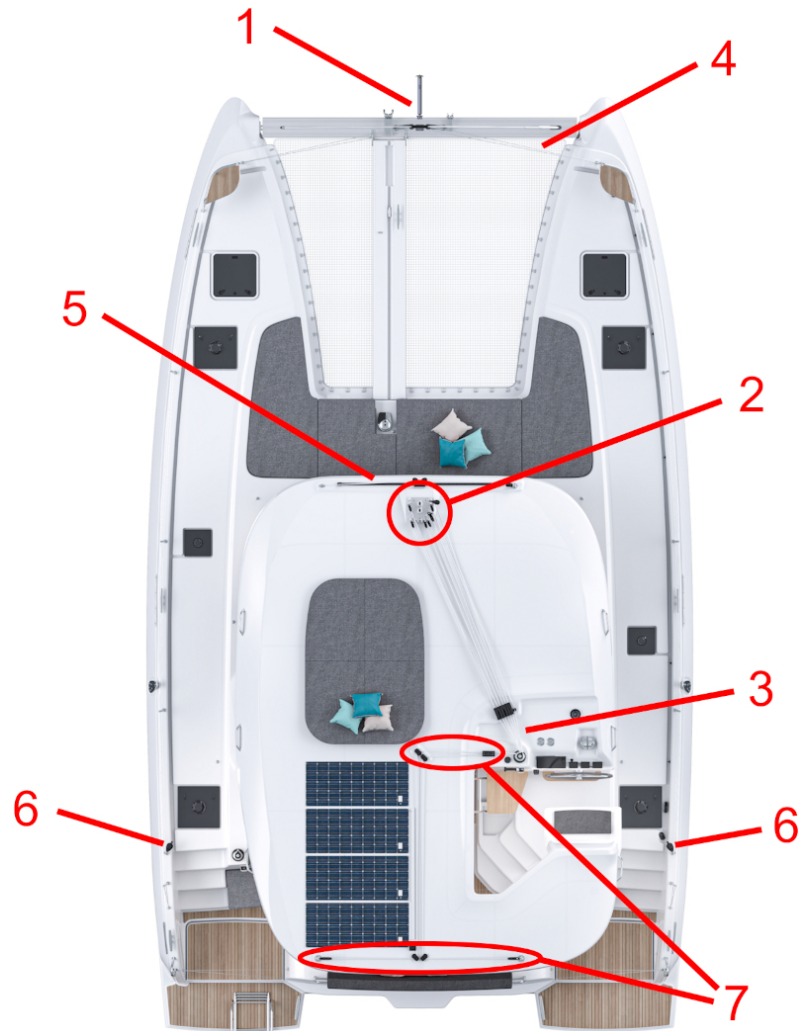

1. Spinnaker pole (Code 0)
2. System at mast foot
3. Rigging diagram
4. Jib circuit
5. Self tacking jib circuit
6. Code 0 sheet
7. Mainsheet system

5 Rigging and sails

System at mast foot

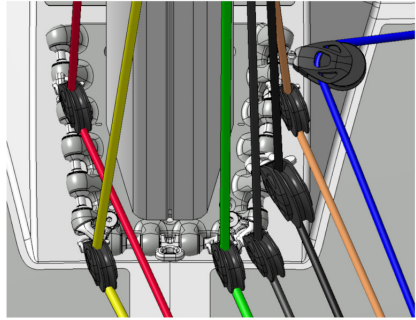

1. Reef 1
2. Code 0 halyard (Option)
3. Reef 2
4. Boom topping lift
5. Mainsail halyard
6. Jib halyard
7. Jib sheet

1 2 3 4 5 6 7

Roof

1 2 3 4 5 6 7

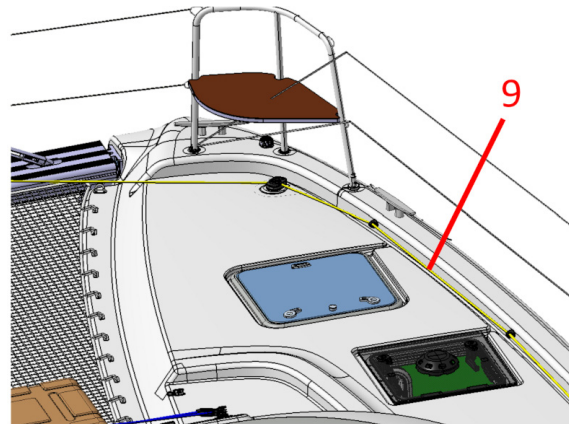
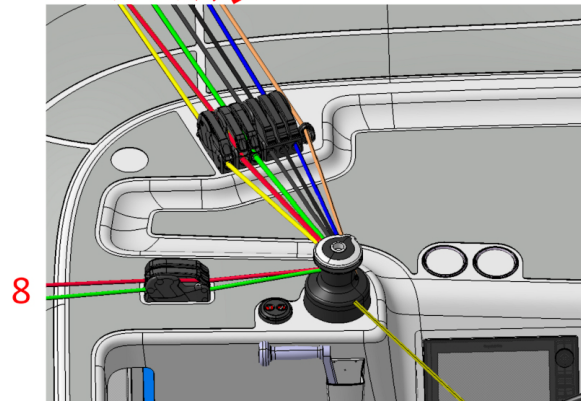

1. Reef 1
2. Code 0 halyard (Option)
3. Reef 2
4. Boom topping lift
5. Mainsail halyard
6. Jib sheet
7. Jib halyard
8. Mainsail traveller
9. Jib furling line

8

9

5.2 Standing rigging



- To hoist a crew member up to the top of the mast, tie a bowline with the halyard directly onto ring of the bosun's chair (never use the halyard snap shackle or a carabiner).
- Hoisting a crew member to the masthead will reduce the boat's stability. The skipper is the sole person responsible for the decision to hoist a crew member up the mast. This decision will depend on sea and wind conditions..

Advice / Recommendation

- The first time you use your boat a high level of skill and attention will be required. The proper functioning of all equipment will depend on the initial set-up being carried out correctly.
The first mast stepping must be carried out under the supervision of the dealer for this reason.
- Before each trip, carefully inspect the mast from top to bottom.
- Every year, check the tension of the rigging and the tightening of the lock nuts and the axis pins of the turnbuckles.

5.3 Running rigging



- When the Genoa with furler is in position, the Genoa halyard must always be fully tightened. Regularly check the tension of the Genoa halyard when underway.
- When the Genoa sail with furler is removed (during winter lay-up or for maintenance, for example), it is important to keep the Genoa halyard away from the forestay which could cause the halyard to break and the boat to be demasted.

- Check the general condition of the halyards and sheets and look out for any signs of wear.
- Regularly check the condition of the cams.
- Regularly clean the blocks with fresh water.
- Avoid aggressive gybing in order to reduce premature wear on the sheets, attachment points and gooseneck.
- If halyard tension (mainsail/genoa) is too great, this can lead to problems when hoisting/furling.

5 Rigging and sails

5.4 Sails

The boat is fitted with one or more fuses to prevent overloads on the rigging (e.g.: mainsail sheet tackle, code 0). If the fuse blows, it is imperative to replace it with a fuse of the same or lower rating to maintain the validity of the warranty.

Sail reduction table



Apparent wind: 30-70°				Apparent wind > 70° # or Apparent wind: 30-70° & Waves > 2m			
Apparent wind (Knots)	Mainsail	Genoa	Code 0	Apparent wind (Knots)	Mainsail	Genoa	Code 0
0-10	High	100%	100%	0-16	High	0%	100%
0-26	High	100%	0%	# 0-10	High	0%	100%
26-31	1st reef	100%	0%	# 0-20	High	100%	0%
31-36	1st reef	75%	0%	# 20-24	1st reef	100%	0%
36-40	2nd reef	60%	0%	# 24-30	2nd reef	75%	0%
40-45	2nd reef	40%	0%	# 30-34	3rd reef *	60%	0%
45-55	3rd reef *	0%	0%	# 34-38	3rd reef *	40%	0%
> 55	0%	0%	0%	# 38-50	0%	25%	0%
				> 50	0%	0%	0%

<p>*: 0 % if the mainsail is fitted with 2 reefs.</p>	<p><i>It is forbidden to sail with front sail only including spinnaker, excluded stormjib. Never sail upwind under Code 0 with TWS exceeding 10 knots. Standing rigging loads must be checked every year.</i></p>
-------------------------------------------------------	---------------------------------------------------------------------------------------------------------------------------------------------------------------------------------------------------------------------------

5.5 Deck fittings

General points

- Inspect each piece of deck gear regularly (blocks, shackles, swivels, cams, etc): Check that there is no cracking, corrosion or deformation.
- When replacing a piece of deck gear, make sure that you use a model with the same strength specifications.
- Failing to check deck fittings regularly and to replace worn ropes means that a block or hoist may suddenly break, causing an accident involving serious injury and damage to the boat.

5.6 Winches

Manual winches

Do not leave loose ropes on the winches - secure them to cleats.

Electric winches

- A load controller is fitted to the electrical circuit: This system protects the winches against overload by temporarily interrupting the electrical supply. The load controller is programmed in the factory.
- Inserting a winch handle into an unloaded winch automatically disconnects the motor transmission and allows it to be used manually.

Maintenance

- Upon return from sailing always rinse the deck fittings with fresh water.
- Wash deck gear regularly with a gentle soap, turning the sheaves of each block. Rinse afterwards with fresh water.
- Never use grease on deck fittings (except winches).
- Never use caustic-based cleaning materials on deck fittings (such as some teak cleaners).



The use of an electric winch for furling/unfurling the genoa or any other forward sail must be strictly avoided (risk of the forestay breaking which may lead to dismasting).



Avoid bulky clothing, long hair and jewellery that might become caught in the winch when it is moving. Avoid riding turns when using the winches.

Remark

Operating the electrical winches requires heavy battery usage: Make sure the battery bank is systematically recharged after a day's sailing.

Rinse winches regularly with fresh water

5 Rigging and sails

- Rinse winches regularly with fresh water.
- Dismantle, clean and lubricate each winch annually. Parts that have been damaged or worn may need replacing.

Diagram of layout – Electric winch

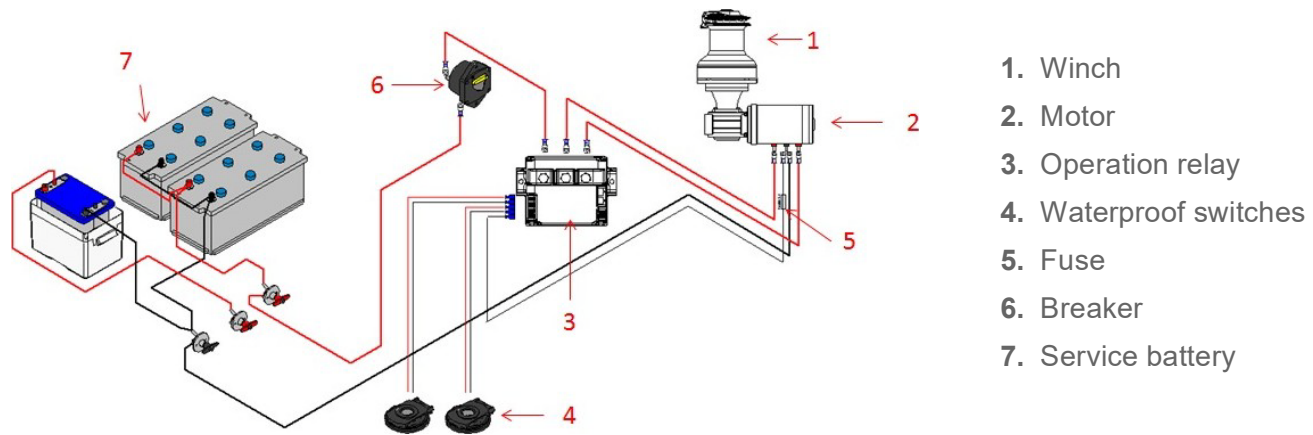

5.7 Genoa furler

Operation

- Leave several turns of the furling line around the drum.
- Furl/unfurl the genoa slowly so that the furling line is always under light tension, thus avoiding any riding turns in the drum.
- Never slacken the genoa halyard when furling/unfurling the sail.
- When furling in light winds, it is recommended that you keep the sheet under slight tension so that the genoa furls correctly.
- Furling and unfurling of the sail are carried out upwind.

Maintenance

- Rinse the furling drum regularly.
- It is recommended that you rinse mechanical parts at least once a year with fresh water.

5.8 Single line furler

General points

Furling and unfurling is carried out downwind.

Maintenance

- Rinse the drum regularly.
- It is recommended that you rinse mechanical parts at least once a year with fresh water.

Safety

6.1 Preventing man overboard situations and means of reboarding

6.1.1 Prevention of man overboard



Use the seats provided.

- The off-limits areas of the working deck when under way are cross-hatched below:



- "Working deck" refers to the exterior parts of the boat where people stand or walk during normal use.

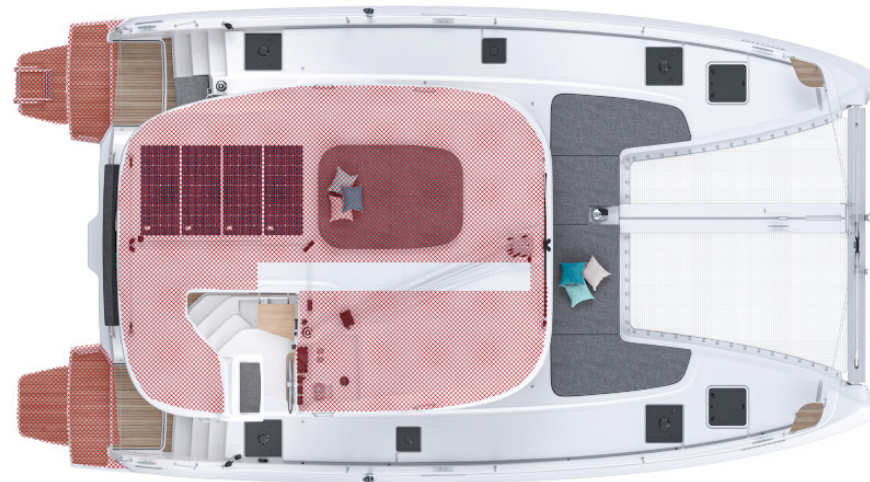

NOTE: Standing on the sunbed must be strictly avoided.

6 Safety

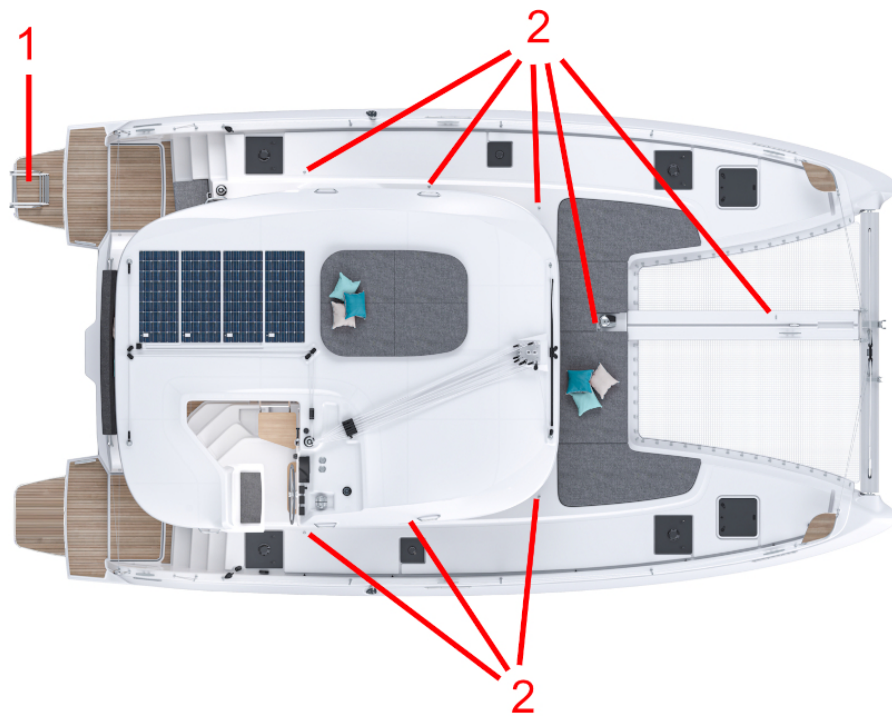

1. Reboarding device
2. anchoring points for lifelines

- Regularly check the tension of the lifelines and the attachment points.
- Regularly check the guardrails:
 - With metal guardrails look out for signs of corrosion (particularly at connecting points).

Reboarding



- Some types of reboarding equipment have a locking device when folded up: It is important to keep the means for getting back onboard deployed and ready to use once the boat is in use (at anchor, moored or at sea).
- Make sure that means for getting back onboard are readily accessible and easy to use by someone alone in the water.

6.2 Storing the liferaft



- Before putting to sea, carefully read the launching instructions shown on the liferaft.
- It is the responsibility of the skipper to ensure regularly that the liferaft is properly secured in place.

The liferaft (not supplied) must be stored in the space provided for it (Ref 1). In category A, the life raft must be installed on the transom only.

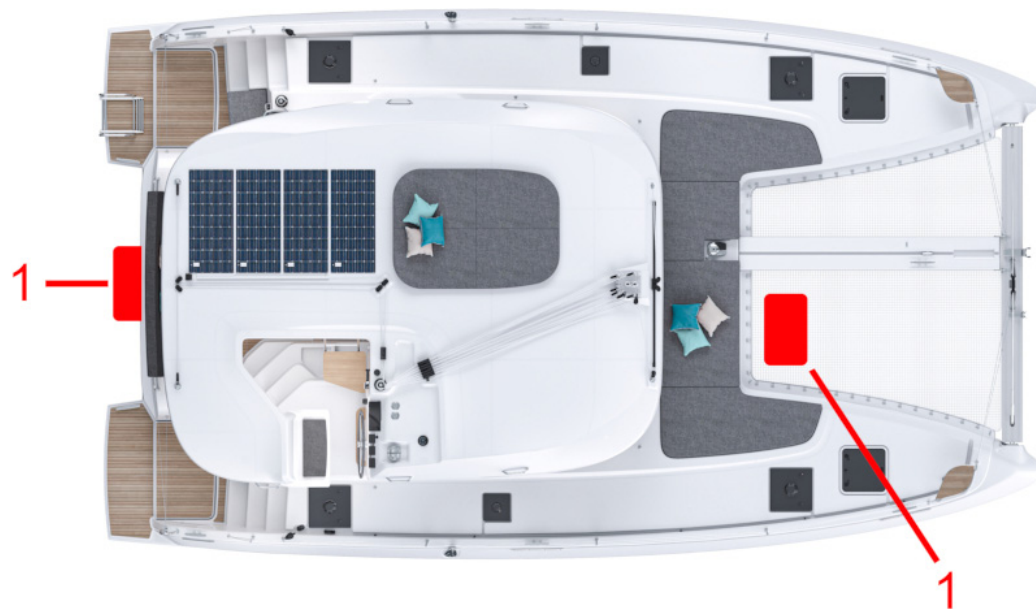

B I B

A pictogram allows for easy location.

6.3 Securing moveable items



Technical areas may not be used as storage compartments.



The maximum weight of the outboard engine on the pushpits must not exceed 20 kg.



- Ensure that movable items are firmly secured when sailing.
- Do not store anything below the floorboards.

- The technical areas are identified in the boat by the pictogram below:

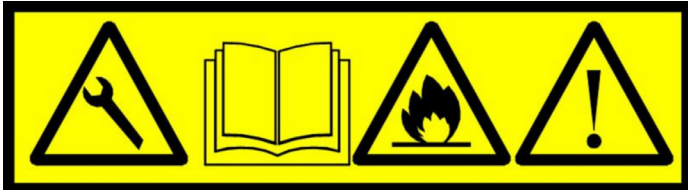

- The electrical technical areas are identified in the boat by the pictogram below:

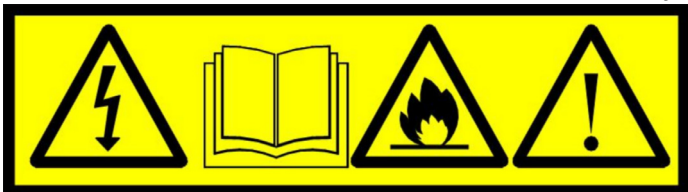

6.4 Emergency systems in case of steering gear failure

Emergency tiller

The emergency tiller is designed only to enable navigation at a reduced speed in case of steering gear failure.

Location of components

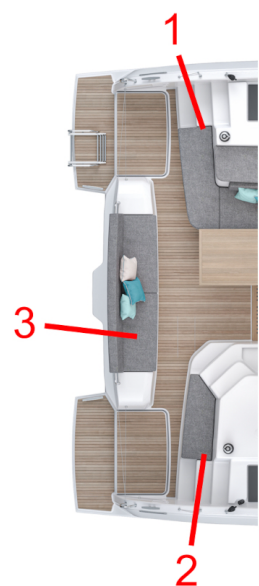

1. Port emergency tiller access point
2. Starboard emergency tiller access point
3. Emergency tiller

Instructions in the event of steering gear failure

- I. Unscrew the filler using a winch handle (Ref 1).
- II. Fit the emergency tiller (Ref 2) into the fitting on the rudder post.

6.5 Information on lightning-related risks

- If the boat has been struck by lightning, the compass and electronic and electrical equipment must be examined to determine whether any damage or calibration change has occurred.
- If the vessel has been struck by lightning, the lightning protection device must be inspected for damage and to verify the integrity of the device and continuity of the earthing.

6.6 Informations in case of grounding of impact



The outer skin of your boat is strong enough to withstand the design pressure but it is not designed to withstand local damage caused by impacts from hard or sharp objects. If the outer skin is damaged, it must be repaired immediately.

- In the event of grounding or impact with an unidentified floating object, lift the floors and check that there is no leakage of seawater.
- If there is a leak of seawater (even a small one), reduce speed, contact the emergency services and follow their advice.
- Take the boat out of the water immediately and have it professionally inspected.
- In the event of grounding, it is recommended to get a professional to carry out an ultrasound test to inspect the keel and its connection with the hull.

Information relating to fire risks and risks of explosion

7.1 Propulsion engines and other fuel-burning equipment



The risks associated with motorisation are described in the ENGINE chapter.

Note concerning the boat's tender



The risks associated with other fuel-burning equipment are described in the FUEL-BURNING EQUIPMENT OTHER THAN FOR PROPULSION chapter.

- If the tender is fitted with a more powerful outboard motor than 25kW, it must have on board a portable extinguisher with a rating equal to or greater than 8A / 68B.
- Place for storage of tender petrol tank: on deck.

7 Information relating to fire risks and risks of explosion

7.2 Electrical system



The risks associated with the electrical systems are described in the ELECTRICAL SYSTEM chapter.

7.3 Gas system



The risks associated with the gas system are described in the LIQUEFIED PETROLEUM GAS (LPG) SYSTEM chapter.

7.4 Fire fighting and prevention equipment

7.4.1 Fire-fighting equipment

Portable fire-extinguishers and fire blanket (not supplied)

When in use, this boat must be equipped with portable fire extinguishers of the following extinguishing capacities, located in the following places:

3-cabin layout



4-cabin layout



Location	Minimum extinguishing capacity
Port passageway	5A / 34B
Starboard passageway	5A / 34B
Galley	5A / 34B
Cockpit seat	5A / 34B

7 Information relating to fire risks and risks of explosion

- The location of the portable fire extinguishers is shown by the pictogram below:



- When in use, this boat must be equipped with a fire blanket to protect the cooking equipment and/or the galley, installed in the following place: near the cooking equipment.
- If there is a 8A/64B then no cover is required.

Maintenance of the fire-fighting equipment



Never:

- Obstruct the passages leading to the emergency exits and the hatches;
- Obstruct or block safety controls, for instance fuel shut-off valves, gas taps, electrical system circuit-breakers;
- Obstruct the access to the portable extinguishers stored in lockers;
- Leave the boat unsupervised when cooking equipment and/or heating equipment is in use;
- Modify any of the boat's installations (especially the electrical, fuel or gas installations) or allow unqualified personnel to proceed with modifying these installations;
- Fill the fuel tanks or replace gas bottles while the engine is running or while cooking or heating equipment is in use;
- Use gas lamps in the boat;
- Smoke when handling fuel or gas;
- Obstruct the ventilation of the compartments or spaces, in particular those containing the engines, tanks or batteries.

The owner/person operating the boat must:

- Have fire-fighting equipment checked as frequently as recommended by the manufacturer;
- Replace portable fire extinguishers, if outdated or discharged, with extinguishing apparatus of equal capacity;
- Provide at least one fire bucket with a lanyard, in a readily accessible place, for protection of the deck;
- Have fixed fire extinguishing systems filled or replaced if they have been discharged or have expired.

Responsibility of the owner/boat operator

It is the responsibility of the owner/boat operator to:

- Ensure that the fire-fighting equipment (portable extinguishers, bucket and fire blanket) is readily accessible when there are people onboard;
- Ensure that the engine compartment fire extinguisher discharge port is readily accessible;
- Show the members of the crew:
 - The location and use of the fire-fighting equipment;
 - Location of discharge ports in engine compartment;
 - The location of evacuation routes and fire exits.
- Equip the vessel with one or more portable extinguishers whose heads are compatible with the diameter of the opening in vertical use.
- Unlock all deck hatches and fire escape openings when the vessel is occupied.

Notes for the attention of the boat user

General points

- Check that the bilges are clean and frequently check that there are no fuel/gas vapours or fuel leaks.
- When replacing components of the fire-fighting equipment, use only appropriate components of the same code designation or with the equivalent technical capacity and fire resistance.
- Do not install free-hanging curtains or other fabrics near or above the cooking appliances or other equipment with a naked flame.
- Do not store combustible materials in the engine compartment. If non-combustible materials are stored in the engine compartment they must be secured so there is no danger of them falling on the engine shaft and they do not obstruct access to and from the compartment.
- The fire exits other than the door or main companionway are identified by the following symbol:



7 Information relating to fire risks and risks of explosion

7.4.2 Smoke alarm

General points

- The smoke detector is a photoelectric detector which operates with a 9 V alkaline battery (battery included).
- The detector emits a flashing red light every minute in normal operation.
- The smoke detector is designed to operate between 0° and + 50°C.
- The smoke detector is not designed to stop a fire from breaking out. It serves to warn the people onboard of the danger.
- The detector is a device which warns people onboard in the event of smoke.
Actions to take if the alarm is triggered: The skipper should check the source of the smoke and attempt to extinguish the fire with the resources at his/her disposal. If the fire spreads, the skipper must immediately evacuate the entire crew.
- The service life of the smoke detector is approximately 10 years. Beyond 10 years, replace the smoke detector with an identical device.

Commissioning of the boat

When the boat is first delivered, ensure that the battery protector is removed.



- The smoke detector is not a gas detector.
- The smoke detector is sensitive to dust and steam: avoid exposing the detector to these environments to prevent the triggering of unwanted alarms.
- Never use a rechargeable battery.
- Never trigger the alarm deliberately to check the operation of the detector.
- A dirty detector may activate incorrectly or late. It is important to clean each detector for the safety of people onboard.
- Never cover the smoke detector (with paint or ceiling panels, for example) and in general do not alter the appearance of the detector.
- Do not fit the smoke detector in a different location from the one specified for the purpose.

Maintenance

The smoke detector must be routinely tested when boarding or weekly if staying onboard for a prolonged period of time. If the device is faulty, change the battery. If the device is still faulty after changing the battery, replace the detector with the same model (consult your dealer).

Changing the battery

- The smoke detector will emit an audible beep every minute for a month when the battery level is too low to operate.
- In that case, change the battery as described below:
 - Remove the detector from its mounting (turn anti-clockwise), remove the empty battery and replace it with the same model of alkaline 9 V battery, ensuring a battery life of 5 years.
 - Connect the battery as shown in its housing (ensure the battery polarity +/- is correct).
 - Return the detector to its mounting (turn clockwise) until it fits perfectly.

Annual routine maintenance

- Remove the detector from its housing (turn anti-clockwise) and clean the vents on the side of the device with a vacuum cleaner or a soft brush.
- Use a damp cloth to clean the exterior of the detector cover.

Winterisation

- To ensure optimal operation, it is recommended that the smoke detector is stored for winter in a fresh and well-ventilated place, having removed the battery.
- Once one person is onboard, it is important to replace the smoke detector in the position specified for the purpose, having first reinstalled the battery.

7 Information relating to fire risks and risks of explosion

7.4.3 Extinguisher access port (Engine compartment)

The engine compartment has a port that makes it possible to discharge the extinguishing product inside without opening the usual access hatches.

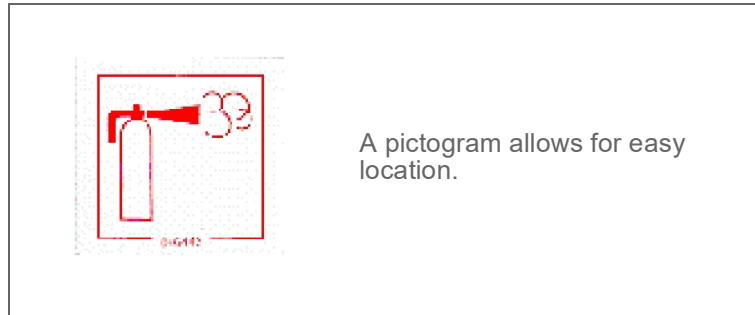

Operation



7.5 Emergency exits in case of fire

Location



- Sliding hatch

7.6 In the event of capsizing

- In the event of capsizing break the glass of the "manhole" cover using the hammer if necessary.
- The life rafts are accessible on the aft beam and on the net (see the beginning of the chapter).

Electrical system

8.1 General information about the electrical system

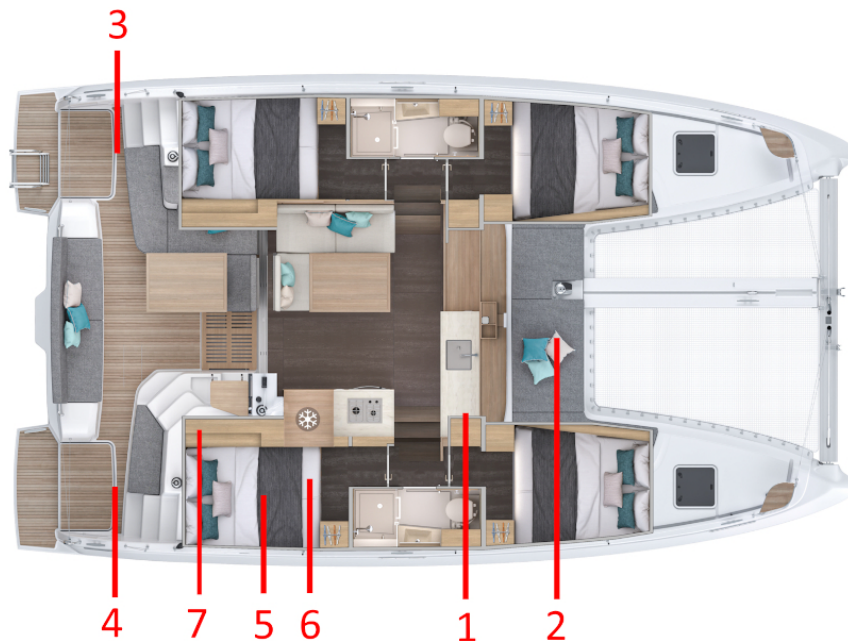

1. Navicolor touchscreen, Electrical panel, Fuses
2. Generator battery
3. Port engine battery, Battery switches, Power distributor
4. Starboard engine battery, Battery switches, Fuses, Power distributor
5. Service batteries
6. Circuit breakers
7. AC breakers



- A risk of fire or explosion may result from careless use of the DC and AC systems.
- A risk of electrocution may result from careless use of the AC system.



- Never:
 - work on a live electrical system;
 - modify the electrical system of the vessel or the relevant diagrams: It is important that installation, maintenance and any modifications be carried out by a qualified marine electrician;
 - change or modify the strength of the safety devices protecting against power surges;
 - Install or replace the electrical devices or equipments with components that exceed the rated current of the circuit;
 - leave the boat unsupervised when the electrical system is live, apart from when the automatic bilge pump and the boat's fire protection and security system are in use (where installed).
- Electrical connections change over time. It is necessary to have the boat's electrics checked regularly and at least once every two years by a professional. Special attention should be paid to the tightness of the electrical connections.

8.2 DC installation (12V or 24V)

8.2.1 Battery use and distribution

General points

- It is essential that a professional engineer connects the batteries when the boat is first launched.
- Always check the condition of the batteries and charge system before putting to sea.
- The battery banks are isolated from one another by a charge divider.

Lithium iron-phosphate batteries (LiFePO₄)

- If the lithium batteries option is installed on the boat, these batteries are located in the starboard engine compartment.
- A smoke detector is installed. It must be kept in working condition (change the batteries annually).

Remark

If the engine is started several times in a row to recharge the lithium batteries, the engine battery may discharge completely. The charger will charge the lithium batteries first, before charging the engine battery.



- All work carried out on a battery must only be carried out by someone qualified to do so. Whenever working on a battery, wear safety goggles and protective clothing.
- Never smoke or produce a spark near a battery: this may cause an explosion.
- If any acid accidentally splashes on your skin or in your eyes, rinse it off immediately and thoroughly with fresh water. See a doctor immediately.
- Never touch the battery terminals: you may suffer an electric shock.
- It is essential that you disconnect the battery charger before disconnecting the battery terminals for maintenance (either by disconnecting the AC shore power socket or by cutting the AC circuit breaker of the battery charger).



- Do not disassemble, drill into or open the lithium batteries.
- Do not use a charger other than the one supplied with the batteries.
- Do not leave a battery on prolonged charge when not in use.
- Never touch the battery contacts or let conductive objects touch the contacts.
- Keep batteries away from water, dust or fire.
- Do not reverse the power cable connection (polarity).
- Do not short-circuit the battery.

8.2.2 Battery switches



- Turn off all battery isolators before leaving the vessel: **failure to do so may result in critical damage to the entire battery bank.**
- Avoid touching the battery isolators when they are live.
- Never switch off the battery isolators when the boat's engine is running (risk of serious damage to the charging circuit).

8.2.3 Power distributor

- The electronic charge dividers isolate the battery banks from each other and allow the charge to be directed automatically to the battery with the lowest charge. They provide the advantage of preventing a drop in voltage.
- The charge divider is electronic. It is designed to distribute the charging current with a low voltage drop between the battery banks (engine and service batteries). It prevents the current from circulating from one battery to another. When the voltage of the charger or alternator is available, the charge divider indicator lights up green.
- The load distributor is integrated in the power unit.

8.2.4 Battery charger

- The battery charger runs on AC power.
- A breaker protects the electrical circuit.
- The battery charger charges all of the batteries onboard while keeping the service battery bank isolated from the engine's battery bank.

8.2.5 Diagram of layout - DC electrical circuit

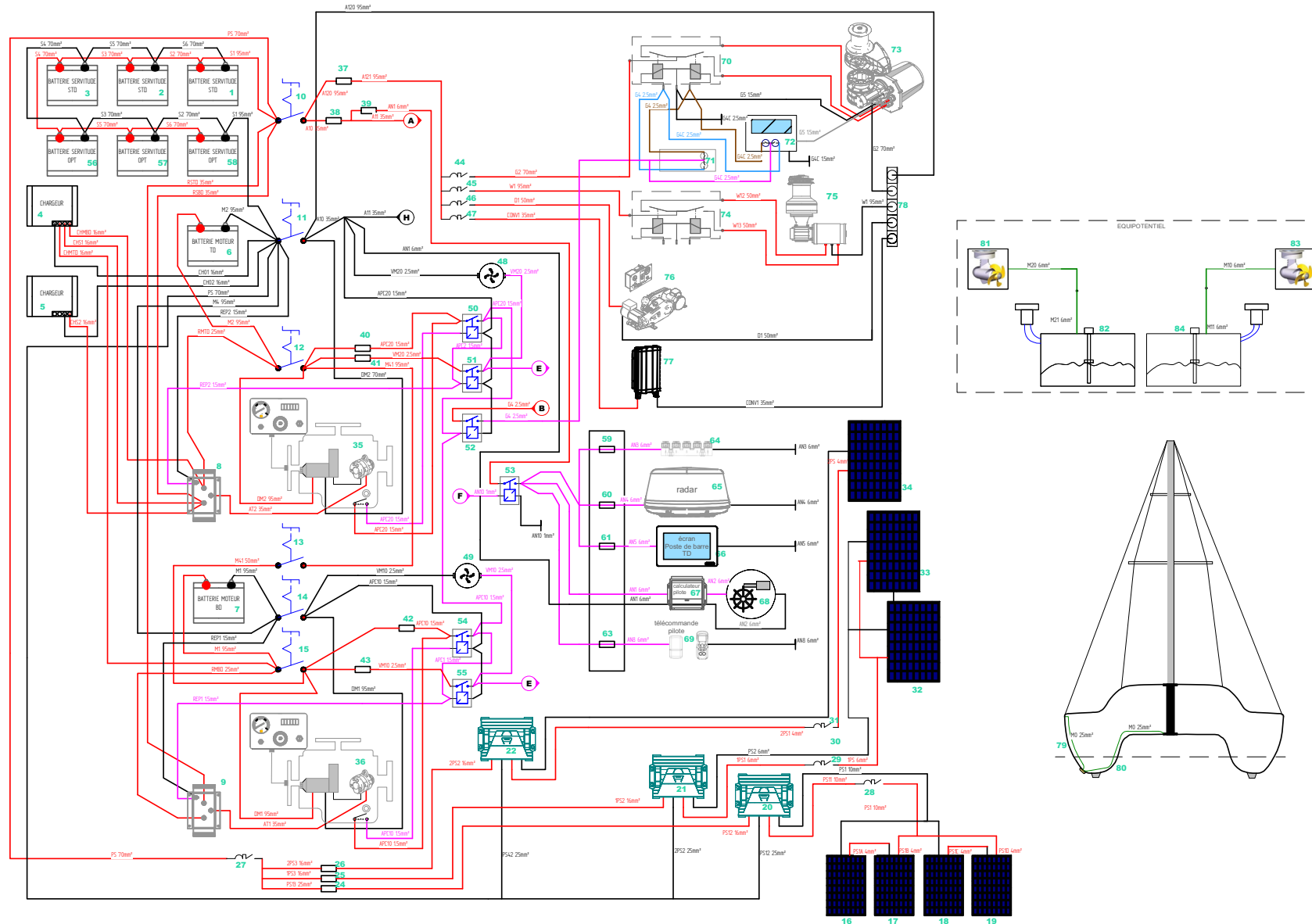

8.2.6 Installation of the hull wiring loom - DC electrical circuit

3 cabins 2 heads version

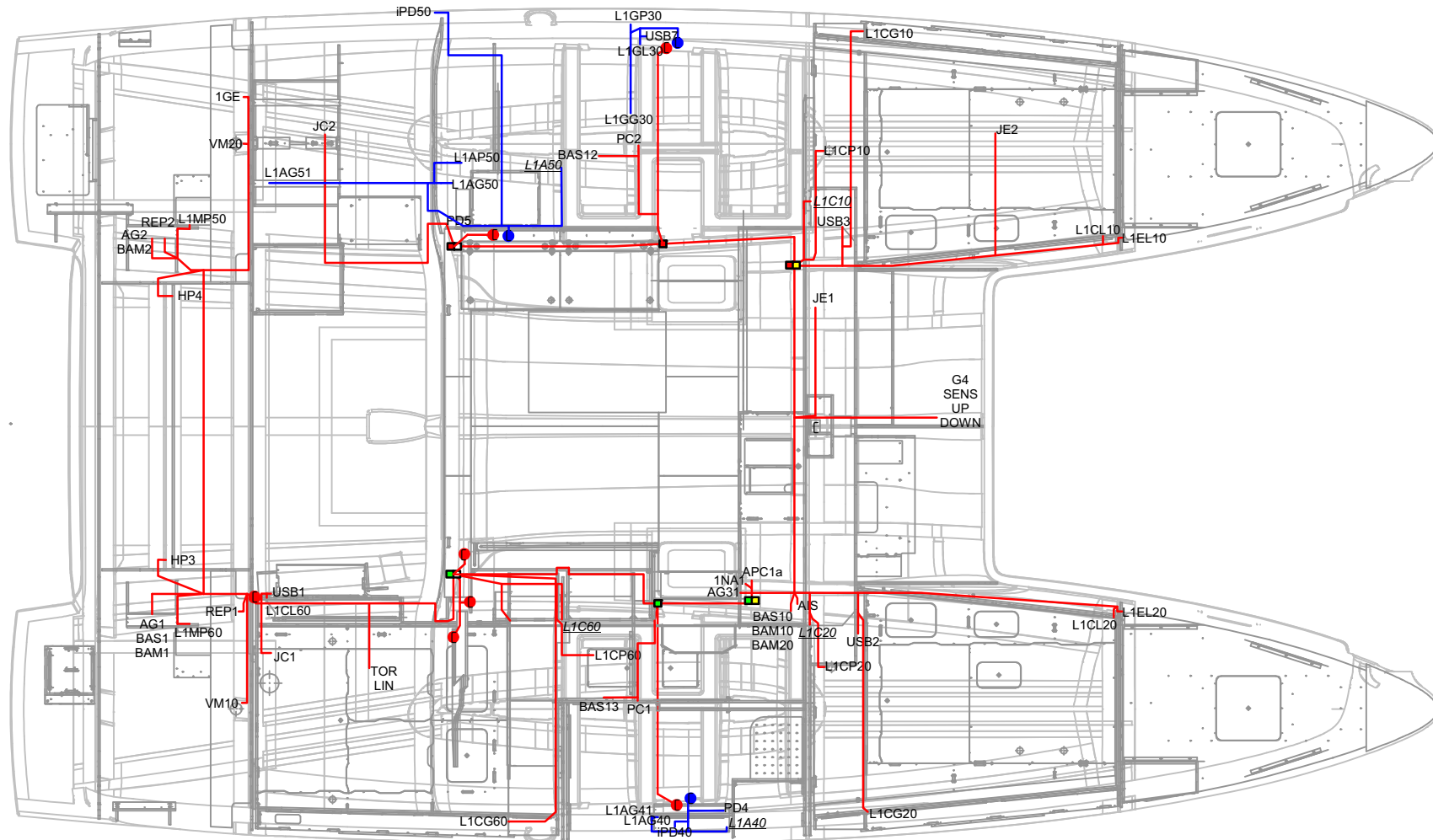

8 Electrical system

4 cabins 2 heads version

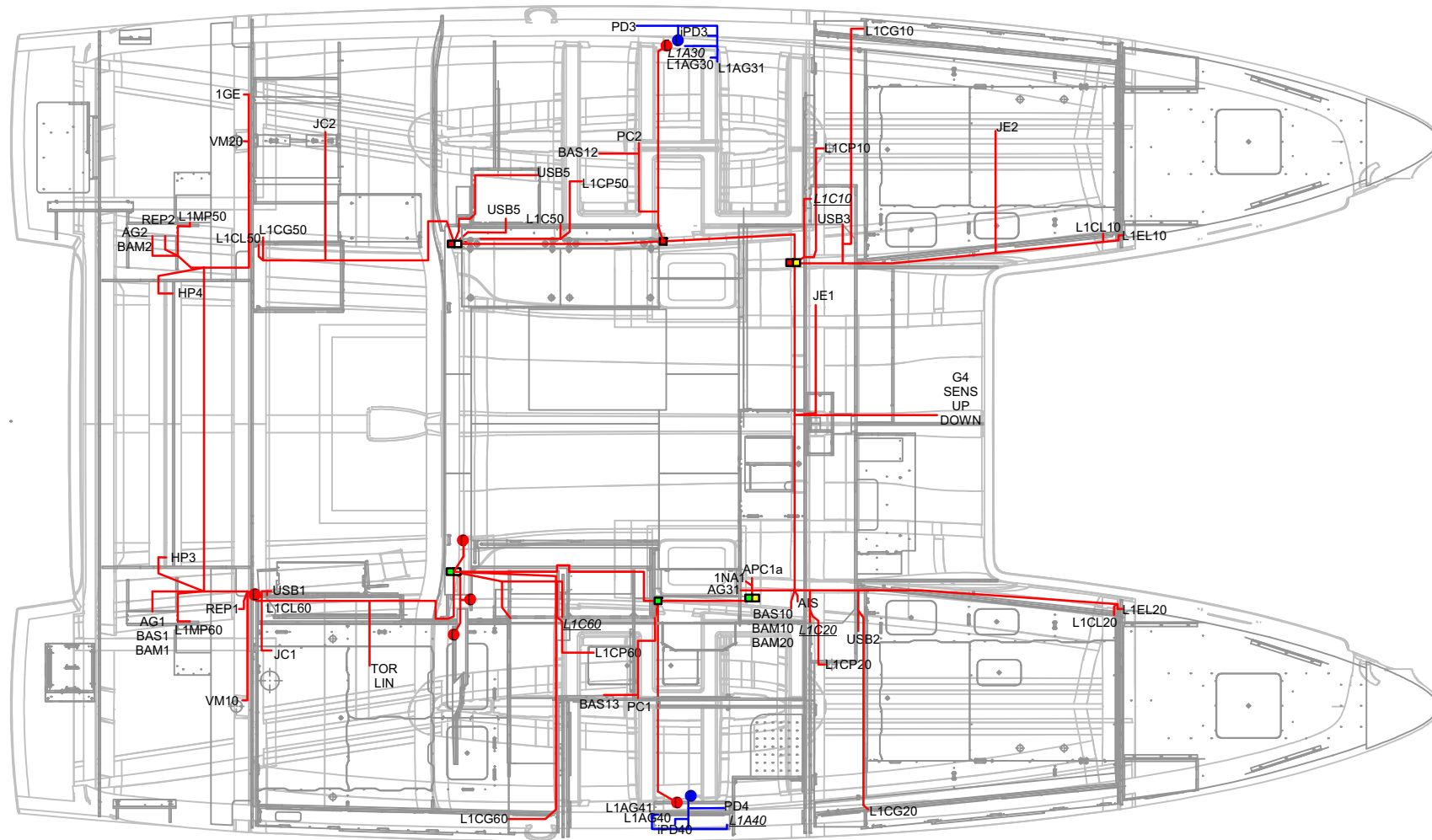

8.2.7 Installation of roof wiring bundle - DC electrical circuit

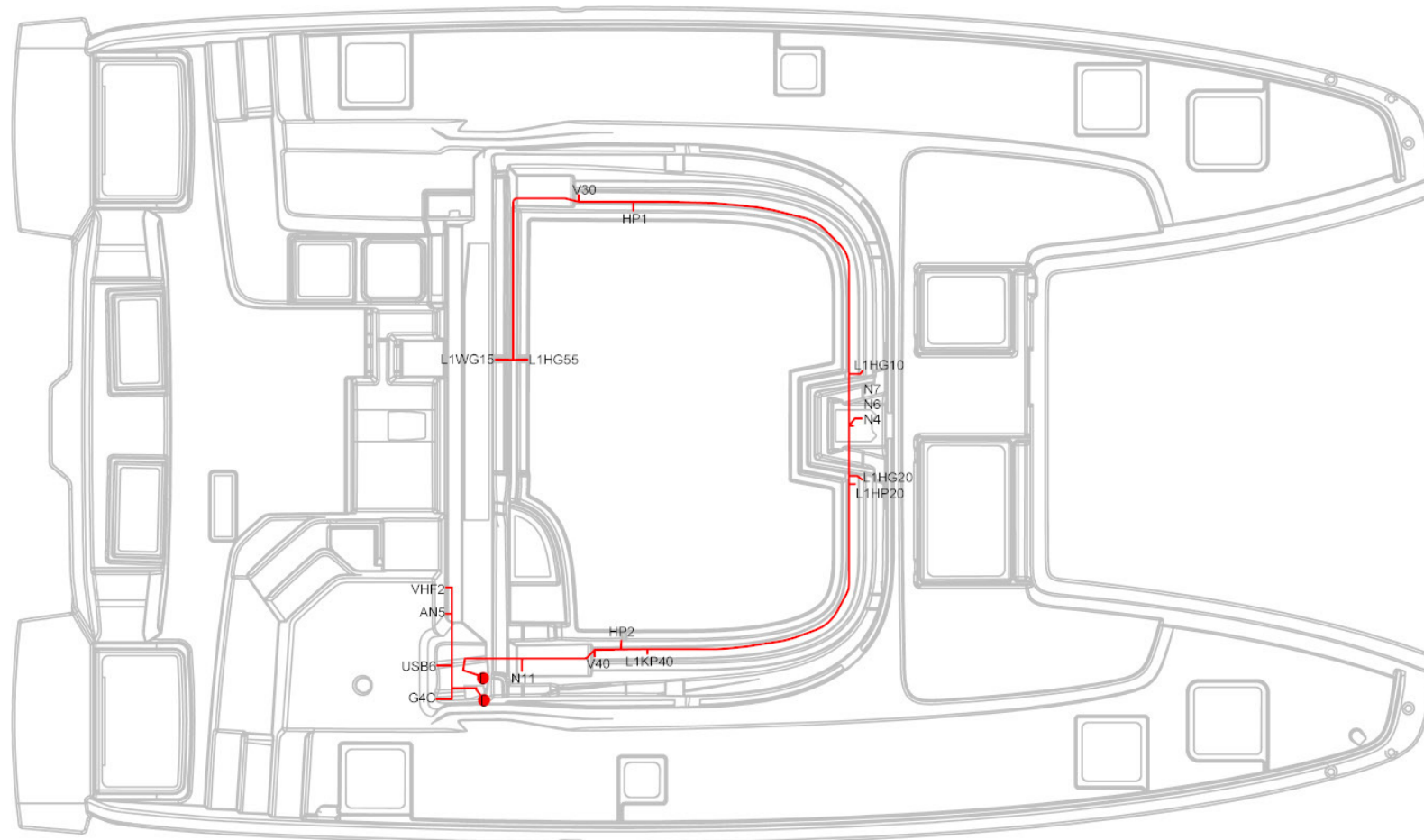

8 Electrical system

8.2.8 Electrical panel

Location: Chart table

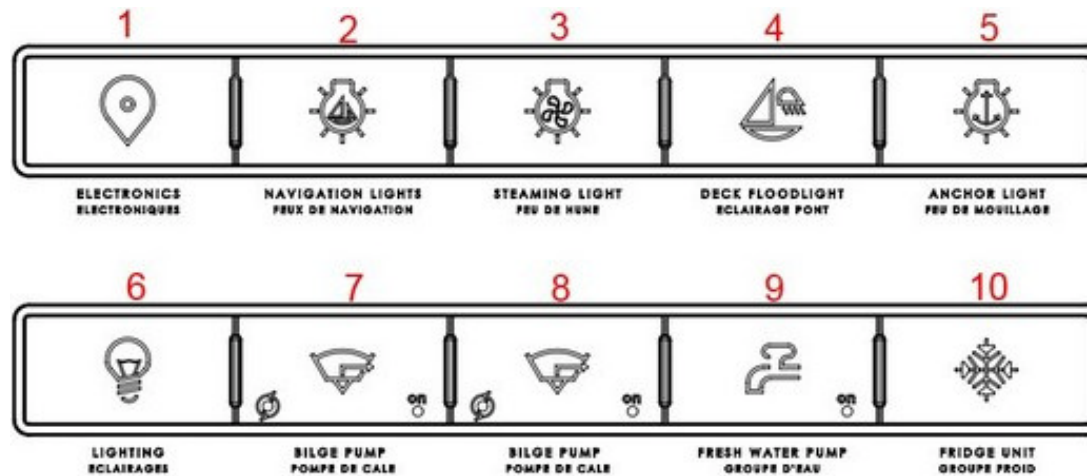

- | | |
|---------------------------|---------------|
| 1. Electronic instruments | 6. Lighting |
| 2. Navigation lights | 7. Bilge pump |
| 3. Steaming light | 8. Bilge pump |
| 4. Deck light | 9. Water unit |
| 5. 360° light | 10. Fridge |



Remark

- The 10 silicone keys switch on the desired DC elements via relays.
- When one of the switches on the panel is flashing, it means that the circuit breaker behind the electrical panel of the faulty switch must be reset.

A circuit breaker protects the circuit of each DC component. An additional fuse holder allows the desired element to be supplied directly by shunting the relay.

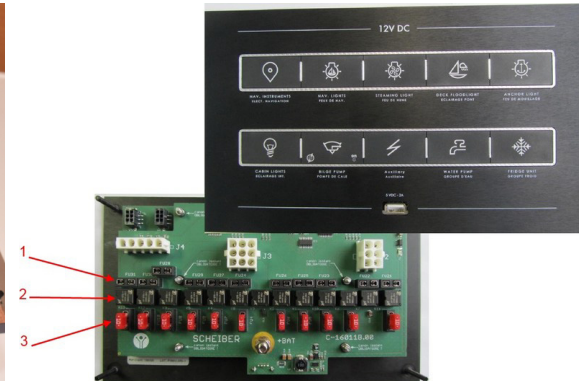
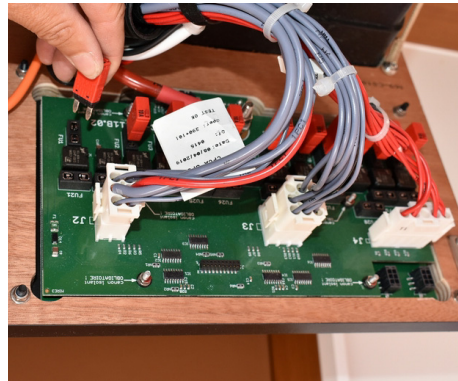

1. Additional fuse holder (for inserting a fuse to power a DC component in defect mode)
2. Relay box
3. Fuse

Designation	Safety fuse	Fuse in defect mode (by-pass)
Water unit	FU 3	FU 23
Electric bilge pump	FU 2	FU 22
Auxiliary	FU 4	FU 24
Refrigeration unit	FU 1	FU 21
Navigation lights	FU 8	FU 21
Steaming light	FU 9	FU 29
360° light	FU 7	FU 27
Electronic instruments	FU 5	FU 25
Deck light	FU 6	FU 26
Lighting 1	FU11	FU 31
Lighting 2	FU 10	FU 30

8.2.9 Fuses



When replacing fuses/circuit-breakers, always ensure replacements are of the correct capacity (see the colour-codes)



A fuse protects an electrical circuit from excess current. If it blows, you must replace it with another fuse of the same rating.

8.3 AC system (110V or 220V)

8.3.1 General points

Guidelines for using the AC electrical system correctly



- If a DC/AC converter is fitted on board: it is essential to switch off the DC and AC circuits before working on the cabin AC sockets.
- Never let the end of the boat/shore supply cable hang in the water: This may result in an electric field that could injure or kill nearby swimmers.
- Incorrect use of alternating current systems will result in a danger of electrocution.
- Do not work on a live AC system.



- To reduce the risk of electric shock and fire:
 - Switch off the switch on the boat's shore cable before connecting or disconnecting the power cable from the shore cable.
 - Connect the shore cable to the boat's power supply input connector before connecting it to the shore socket.
 - If the reverse polarity indicator is activated, immediately disconnected the switch of the shore to boat cable (if fitted).
 - If the reverse polarity indicator is activated immediately disconnect the cable.
 - First disconnect the shore line on the quay.
 - Ensure the protective cover of the power supply input of the shore to boat cable is properly closed.
 - Do not alter the connections of the shore power supply cable: only use compatible plugs and sockets.
- Electrical connections change over time. It is necessary to have the boat's electrics checked regularly and at least once every two years by a professional. Special attention should be paid to the tightness of the electrical connections.

Advice / Recommendation

Every month, you are advised to test the circuit breaker or residual current differential switch, recognisable by its "test" button.

- Do not modify the vessel's electrical installations or the relevant diagrams. Installation, maintenance and modifications must be carried out by an electrician qualified in marine electricity. Have all electrical installations checked (tightening and connections) every year.
- Disconnect the boat's shore power when the system is not in use.
- Connect the relay boxes or metal casings of the installed electrical equipment to the boat's protective conductor (green or green with yellow stripe).
- Use double-insulated or earthed appliances.
- If the reverse polarity indicator is activated, do not use the electrical installation. Rectify the polarity fault before using the vessel's electrical installation (this applies only to polarised circuits with a polarity indicator).

8 Electrical system

8.3.2 AC shore socket



If the power cable falls into the water, it is recommended that the cable is replaced to prevent any risk of fire.

Location of components



1. Shore power socket
2. Differential circuit breaker (Protection)

8.3.3 AC source selectors

The shore-generator switch is the actuator for:

- switching between the different AC sources available on the boat. These include the dock socket(s) and the generator.
- measuring the voltage, frequency and current of the power sources connected to it.

8.3.4 Diagram of layout – AC electrical system

Europe Version (220V / 50Hz)

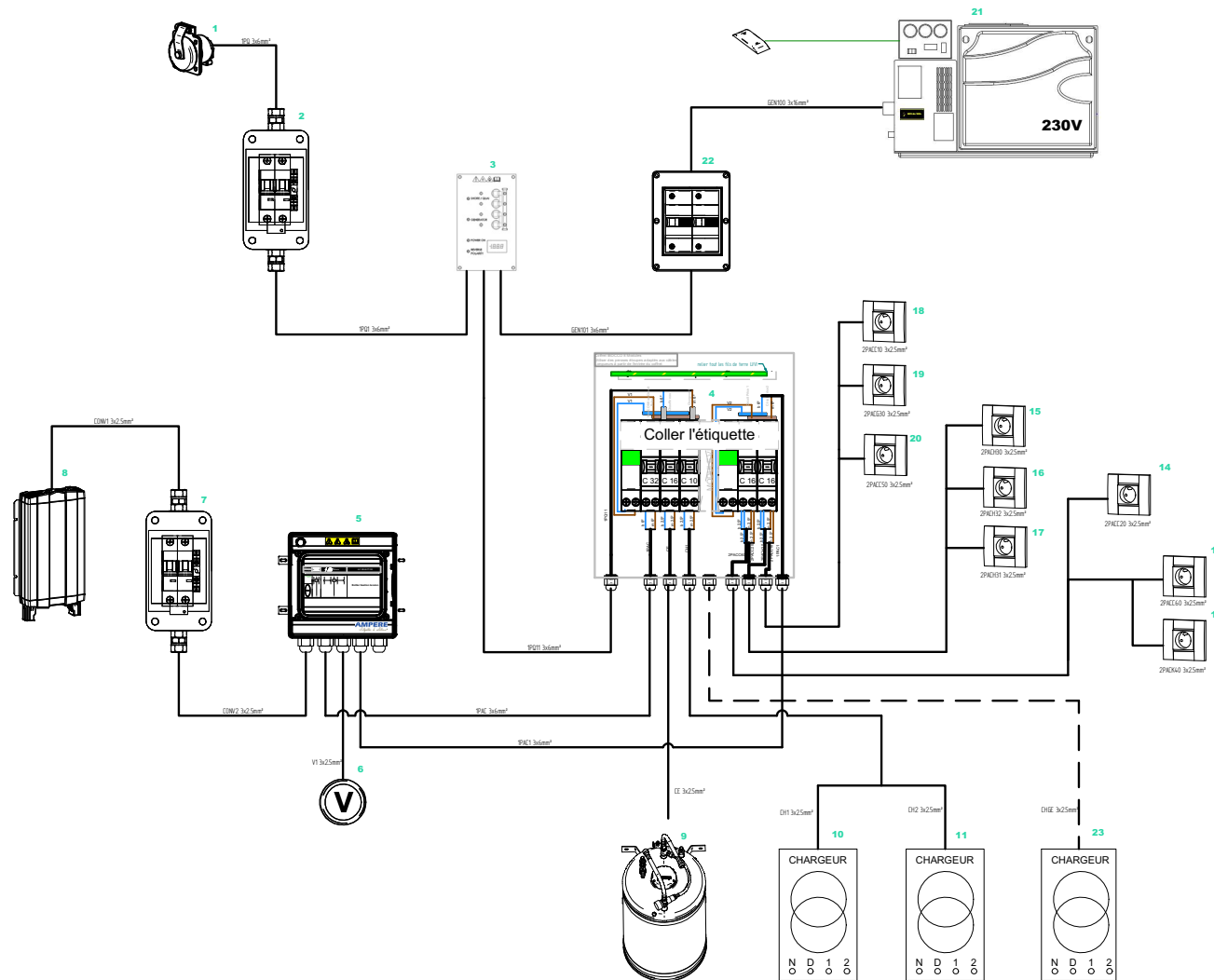

8.3.5 DC/AC converter



Never:

- connect the inverter AC lead to an AC terminal or to the onboard generator.
- disconnect the wiring from the inverter when in use.
- open the inverter.

Description

- The inverter converts the DC voltage of the service battery bank to AC voltage. The circuit between the inverter and the batteries is protected by a fuse or a circuit-breaker.
- The inverter is earthed by an earthing plate located under the hull (see Chapter: EARTHING PLATES).
- The voltage measurement delivered at the converter output is visible on the touch screen.

Operation

Remark

Simply cutting the AC power supply at the switch panel does not cut the AC power supply to the cabins: it is also necessary to disconnect the DC supply.

Power supply for the 220V AC electric sockets in the cabins:

- Once there is sufficient nominal voltage coming from the AC switch panel, AC power is supplied by the onshore socket or by the generator.
- If there is insufficient nominal voltage coming from the AC switch panel, the AC power supply automatically switches over to the inverter. In this way, the power for the 220V sockets in the cabins can be supplied by the inverter, itself supplied by the service battery bank. Be careful to disconnect the inverter circuit to prevent the AC power supply automatically switching over and to prevent accidental discharge of the service battery bank. This can be done by:
 - setting the inverter's circuit-breaker to the OFF position; or,
 - setting the switch located on the inverter to the OFF position.
- Simply cutting the AC power supply at the switch panel does not cut the AC power supply to the cabins: it is also necessary to disconnect the DC supply.

8 Electrical system

Operation

- The inverter is fully automatic.
- A remote control is located near the boat's switch panel. To start the converter put the switch on the inverter in the "REMOTE" position then put the switch located on the remote control in the "ON" position.
- If the switch on the inverter is in the "OFF" position, you cannot use the remote control to start it.
- The DC/AC converter operates by default when shore power is not supplied. It is controlled by a relay connected to the shore power supply. This converter powers the indoor sockets and some onboard appliances.
- When shore power is not connected, the relay automatically connects the inverter to a part of the onboard AC circuit.
- When the shore power socket is plugged in and powered, the relay automatically disconnects the inverter.

Maintenance

- Check at least once a year that the inverter cables and connections are securely tightened.
- Clean the inverter by removing any accumulated dust to ensure good ventilation.

8.4 Protection against electrolysis / Earthing plate

8.4.1 Anodes



- Never cover the anodes in antifoul.
- During the first few weeks that the boat is in the water, check the anodes and replace them if necessary: they erode very rapidly during this period.

General points

- The sacrificial anode protects the submerged elements of the boat against electrolysis.
- A sacrificial anode is a consumable part that protects submerged metal parts by its dissolution (oxidation). The anodes used are made of a metal that is more readily reductive than the metal they are protecting.
- On a new boat, all the underwater metallic components seek to reach the same electric potential, which leads to the rapid deterioration of the anodes during the first few weeks in the water.
- You can put several anodes on the hull.

Cleaning anodes

Use emery paper. Do not use metal brushes or steel tools to clean the boat as this may damage the galvanic protection.

Maintenance

- At least 2 times a year, check the corrosion on all of the anodes. Change the anode if necessary (Before it has lost 50% of its weight).
- Use the appropriate anodes for the cruising area: magnesium anodes for fresh water; zinc anodes for seawater.
- If the motor mountings are raised, the anodes are out of the water: in this case the anodes can no longer protect the sterndrive: take note of the skipper's recommendations.
- When the boat is kept in a dry dock, a light deposit of dust will settle on the anodes: clean the anodes before relaunching.

Replacing the anodes

- The anodes are fastened with screws and nuts. First, remove the screws and nuts that hold the anode, then clean the contact surface. Press the new anode to obtain a good electrical contact.
- Change all the anodes every year.

8 Electrical system

8.4.2 Earthing plates



Never antifoul over the earthing plates.

- An earthing plate is a shot-peened plate mounted on the hull to recreate an earth neutral point on the electrical circuit of the equipment supplying AC power (AC/DC converter). The earthing plate earths this equipment.
- The earthing plate is not an anode: it must not be allowed to deteriorate.
- If the earthing plate deteriorates, consult a professional immediately to determine the cause. Because it is mounted across the hull below the waterline, deterioration of the earthing plate puts the boat at risk of sinking.

Location



1. Inverter earthing plate
2. Generator earthing plate

Liquefied Petroleum Gas (LPG) System

9

9.1 General points

- The working pressure of the LPG unit is 28 millibars
- Recommended cylinder capacity:
 - Europe Version: 2,75 kg of butane.
 - US Version: 5 lb of propane.
- Have the hoses, the entire LPG system and the flue pipes in the LPG system inspected professionally and regularly (or at intervals determined by the national requirements of the country in which the boat sails), and have them replaced if damage is detected.
- Taps attached to empty cylinders must be closed and disconnected. Protective covers, lids or caps must be held in place. Spare and empty bottles must be stored on the outside of the boat, protected from bad weather and physical damage and where any gas escaping from the bottles can only be evacuated to the exterior of the boat.
- Do not impede access to the components of the LPG system.
- Do not use the housings or the LPG bottle lockers to store other equipment.
- Check the vent pipes at least once a year. Replace them if they have deteriorated or split.

9 Liquefied Petroleum Gas (LPG) System

Location of components

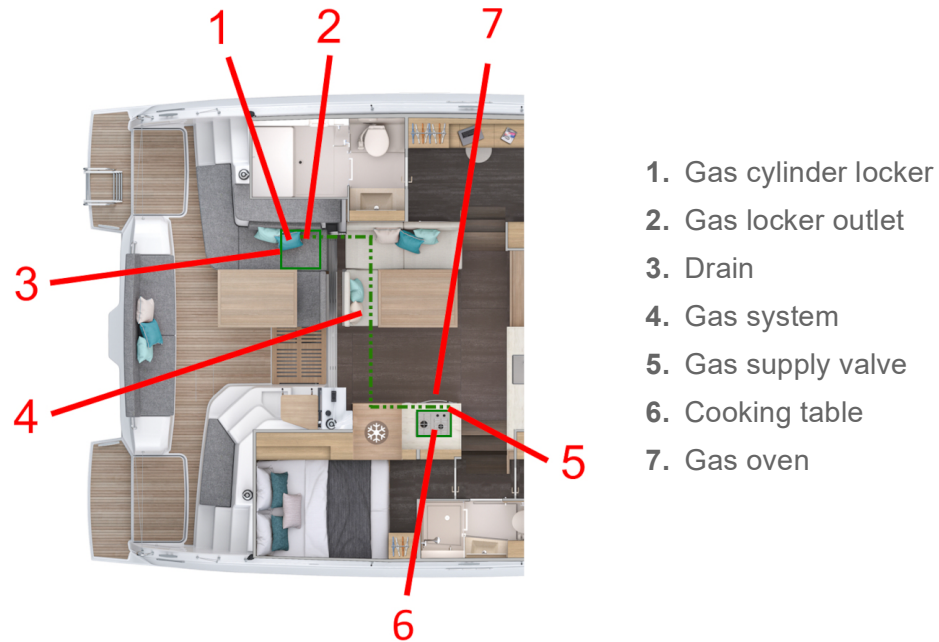

9.2 Operation of the LPG system

- Valves for supply lines and cylinder valves must be closed when appliances are not in use, before changing a cylinder and immediately in case of emergency.
- Appliance valves must be closed before opening the cylinder valve.
- Ventilation is necessary when appliances that consume oxygen from inside the boat are used.
- If the stove is not suspended by gimbals, it should not be used when wide roll angles or continuous listing are likely.
- Please refer to the manufacturer's notes for the use and maintenance of the LPG cooker.

9.3 Verification of the LPG system



- When the cooker is on, ventilate well to prevent any risk of asphyxiation.
- Do not use the cooker as a means of heating.



- If a leak or fire from an LPG tank is detected, close the main LPG supply valve and do not use LPG appliances.
- Do not use an installation with a leak before it has been inspected and repaired by a competent person.
- Do not modify the boat's LPG system. Installation, modification and maintenance should be carried out by a qualified individual. Have the system checked at regular intervals or as prescribed by national requirements.
- Never use a naked flame to check for leaks.
- Do not use a hotplate or an oven to heat the living areas.
- Fuel-burning equipment with a naked flame consumes the oxygen in the cabin and leaves combustion residue in the boat. Ventilation is necessary when this equipment is used. Open the vents provided for this purpose when using this equipment. Do not use a hotplate or an oven to heat the living areas. Never obstruct the openings provided for ventilation.
- Ventilation requirements have been calculated for LPG appliances as installed. Additional ventilation openings may be required if other appliances are installed in addition to these (please consult a professional).
- Never leave the boat unsupervised when equipment using LPG with a naked flame is on.
- Do not smoke or use a naked flame when replacing LPG bottles. Close the tap on the empty bottle before detaching to replace it.
- To ensure sufficient ventilation, make sure that you open the hatches or ports near the hotplate when using it.



Do not use solutions containing ammonia when testing for leaks manually (ammonia, which is present in certain soaps and detergents, attacks brass connections. Although the damage may at first be impossible to detect, the cracks and leaks may appear several months after contact with the ammonia).

Remark

Leak tests carried out by the boat user are not a substitute for regular and complete checks of the LPG circuit by a competent professional.

9 Liquefied Petroleum Gas (LPG) System

The LP system should be tested for leakage before each use in any of the following ways:

- If the LPG circuit is equipped with a pressure gauge:
 - Before each use, close the appliance valve, open the LPG cylinder valve, allow the pressure gauge to stabilize, close the LPG cylinder valve and observe the pressure indicated by the pressure gauge near the LPG cylinder for 3 minutes. The pressure indicated by the manometer should be constant if there is no leak in the system.
 - The pressure indicated by the manometer should be constant if there is no leak in the system. If bubbles are observed in the detector liquid, there is a leak.

Remark

The pressure gauge only indicates vapour pressure, which is a constant at a given temperature. It gives no indication of the amount of LPG remaining in the cylinder..

- If the LPG circuit is equipped with a bubble leak detector, use it as follows:
 - Regularly observe the bubble leak detector.
 - or
 - Once the installation is pressurised and stabilised, press the detector push button. The installation is not leaking if bubbles do not appear in the detector liquid. If bubbles are observed in the detector liquid, there is a leak.

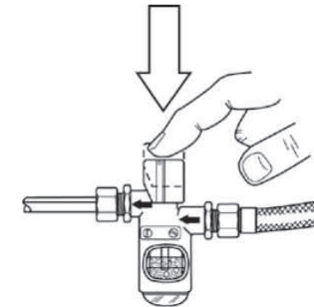

Carry out a manual search by applying a foaming solution, soapy water or a detergent (with the burner taps closed and the installation and gas bottle taps left open). Foaming solutions for detecting leaks in gas installations conforming to EN 14291 are adequate for these requirements.

- If an LPG leak is detected or suspected, immediately take the following measures:
 - Cease use of all LPG appliances;
 - Disconnect the LPG supply from the supply valve(s);
 - Extinguish all naked flames and other sources of ignition (heaters, cooking appliances, pilot lights, etc.);
 - Do not operate electrical switches;
 - Evacuate the area if possible.

To change an LPG bottle:

1. Close the tap on the LPG bottle
2. Detach the LPG bottle
3. Replace the LPG bottle
4. Attach the new LPG bottle
5. Open the tap on the LPG bottle

Water systems

10.1 General points



- Regularly check water-tightness of joints in the water system installations. Check that screws and bolts are well tightened and replace them if they are worn or corroded.
- Disconnect the onshore shore water supply before leaving the boat (if fitted).
- If the boat is sailing in temperatures below freezing, antifreeze can be used in the water systems: use a non-toxic antifreeze for potable water.
- Never use automobile antifreeze: risk of poisoning.

- It is essential to rinse the entire on-board water system the first time the boat is used (the water system is protected in the factory by a non-toxic antifreeze).
- The water tanks may have had an anti-algae treatment using a copper sulphate based product. It is advisable to renew the treatment according to the area in which the boat is sailing.
- Drain all the water systems during winterisation (in particular the cockpit shower and water heater) to avoid damage from freezing.
- Clean/change the filters regularly.
- The onboard water from the boat's tank(s).
- Particular care must be taken when filling the tank(s) to prevent contamination of the entire plumbing circuit with water which is not fit for drinking or food use.

10.2 Information on flooding risks and boat stability

10.2.1 Hull openings

Valves, thru-hull inlets and other brass or bronze fittings have a lifespan of around 5 years. All valves, thru-hull inlets and other brass or bronze accessories must be checked by a professional every year and replaced as necessary.

10.2.2 Drainage system

General points

- It is the responsibility of the skipper to have at least one bailer or bailing bucket on board, lashed down to prevent it being accidentally lost.
- The inner moulding of the hull is equipped with channels: these are the drainage channels. The drainage channels allow the water to drain down to the lowest point in the boat, where it can be discharged. It is important to allow the water to flow freely down to this lowest point of the boat, which means.
- regularly cleaning the lowest point of the boat and the drainage channels.

Diagram of Layout – Bilge pumps

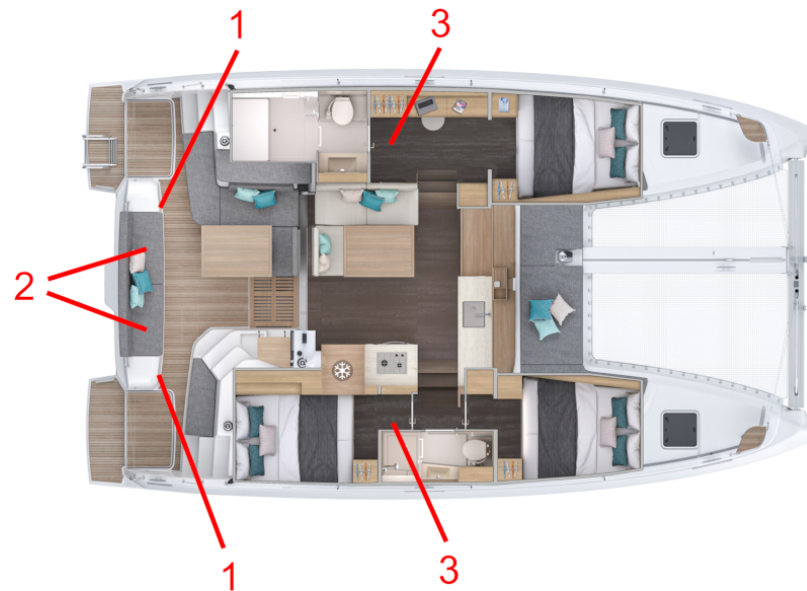

Reference	Designation	Rate
1	Manual bilge pump	32L/minute (*)
2	Manual bilge pump lever	—
3	Electric bilge pump	50L/minute
4	Electric bilge pump switch	—

(*) 45 strokes/minute

Secondary drainage system

Manual bilge pump

- The manual bilge pump is in the cockpit.
- The bilge pump lever is located nearby.

Remark

The manual bilge pump lever must remain accessible at all times.

Operation



- I. Attach the lever to the manual bilge pump.
- II. Repeatedly work the lever up and down to its fullest extent.

10 Water systems

Main drainage system

Electric bilge pumps

The electric bilge pump must only be used to discharge stagnant water at the bottom of the bilge. It must not be used to pump out any oil-based products (petrol, oil) or inflammable liquids.

Control

Location: Electrical panel

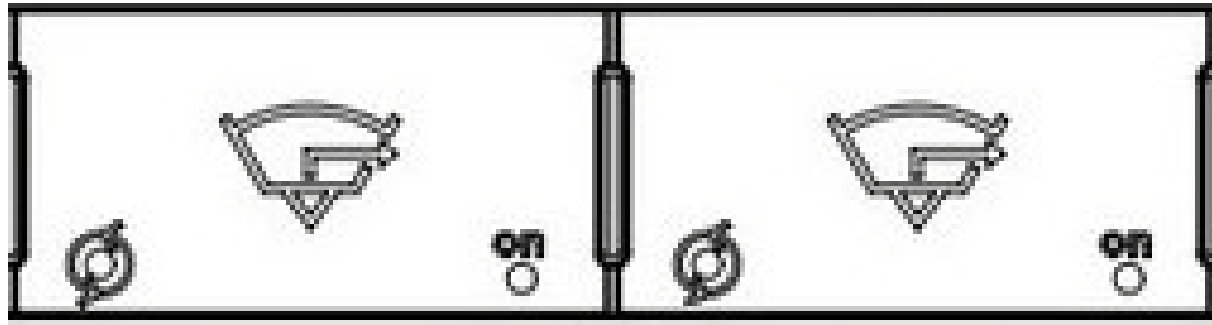

Starboard electric bilge pump

Port electric bilge pump

- Pressing the switch once activates the "automatic" mode of the bilge pump: The pictogram lights up red.
- Pressing the switch twice activates the "forced run" mode of the bilge pump: The indicator light ON turns on (bottom right).
- When the indicator light on the bottom left lights up, the bilge pump is in operation.

Operation

- I. Turn on the battery switches.
- II. Switch on the bilge pump (Ref 4).

If the boat is equipped with an automatic bilge pump, the switch has an always-on position.

Bilge pump maintenance



- The total capacity of the bilge pump system is not designed to drain the boat in case of damage.
- Keep the water level in the bilges to a minimum.
- Never store anything at the very bottom of the boat: Allow bilge water to flow freely down to the lowest point of the boat.
- The bilge pump system is not designed to cope with a breach of the hull.

Advice / Safety precautions

- Check that each bilge pump is working at regular intervals.
- Clear the points and suction filters of the bilge pump of any debris that could clog them.
- Drains must be kept clean and unobstructed.
- If the watertight partitions which seal off the fore and aft points are fitted with valves they must be closed at all times and only opened to drain water into the main bilge.

Diagram of Layout – Drying out the bilge

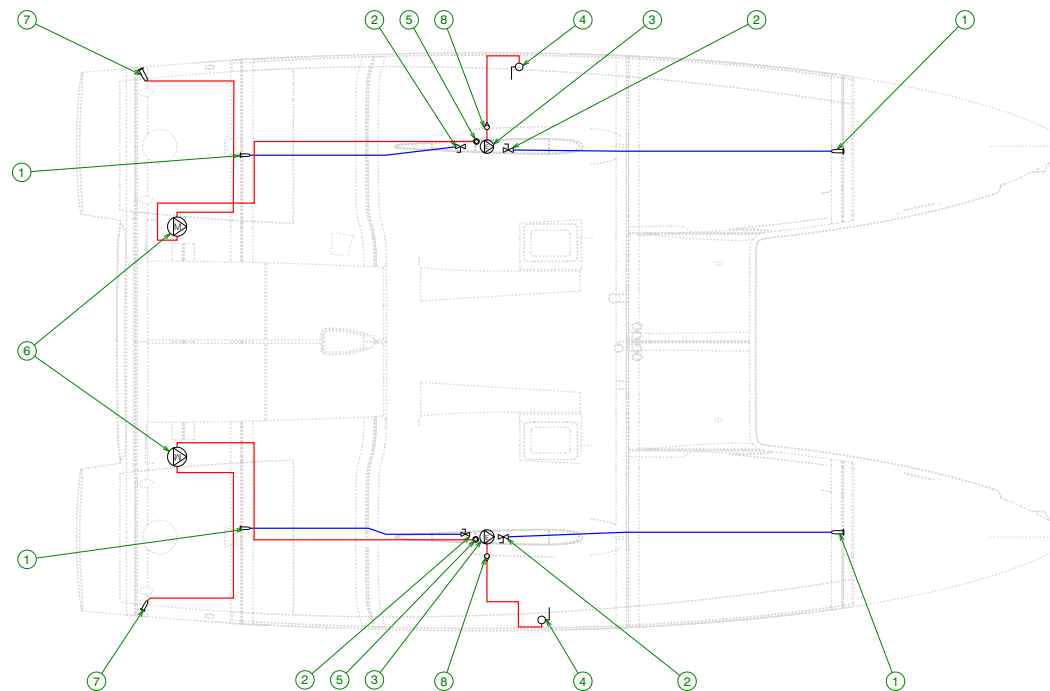

1. Bulkhead fitting
2. Valve closure
3. Electric bilge pump
4. Electric bilge pump drain valve
5. Manual bilge pump suction strainer
6. Manual bilge pump
7. Kitchen sink thru-hull drainage
8. Non-return valve

10.3 Fresh water filling system

standard

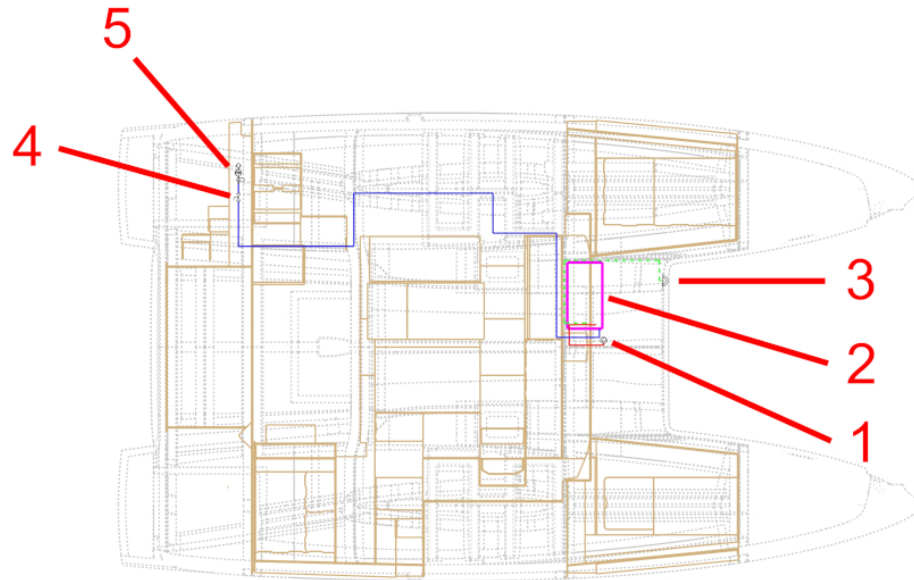

1. "WATER" deck filler
2. Fresh water tank
3. Fresh water tank vent

Option

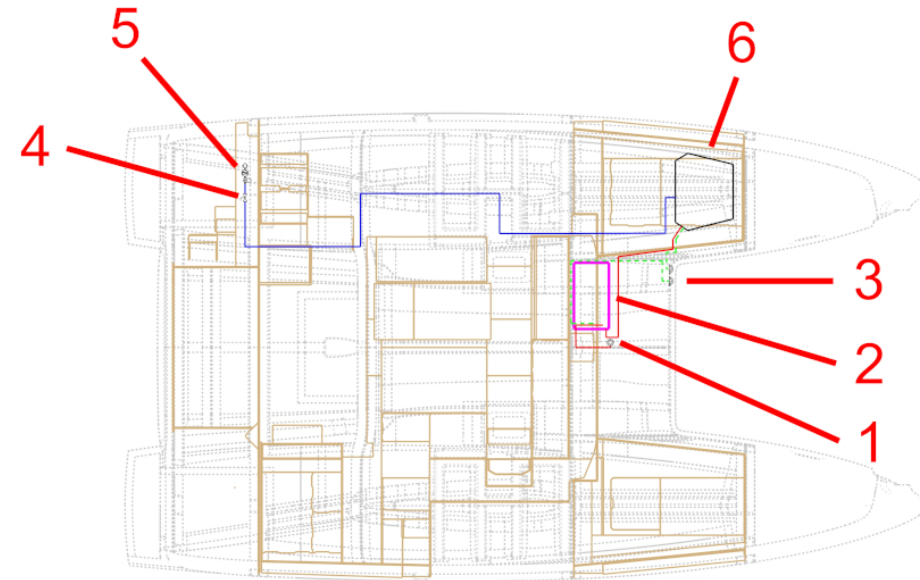

4. Water unit
5. Water tank / water unit supply valve
6. Fresh water tank (Option)

10.4 Fresh water distribution system

3 cabins 2 heads version

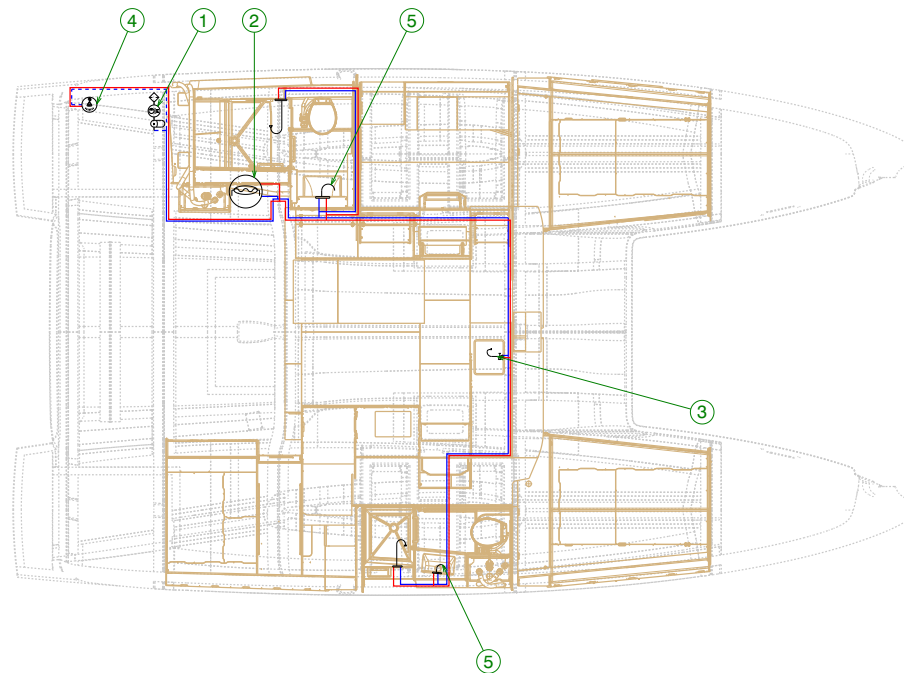

1. Water unit
2. Water heater
3. Galley sink mixer tap

4 cabins 2 heads version

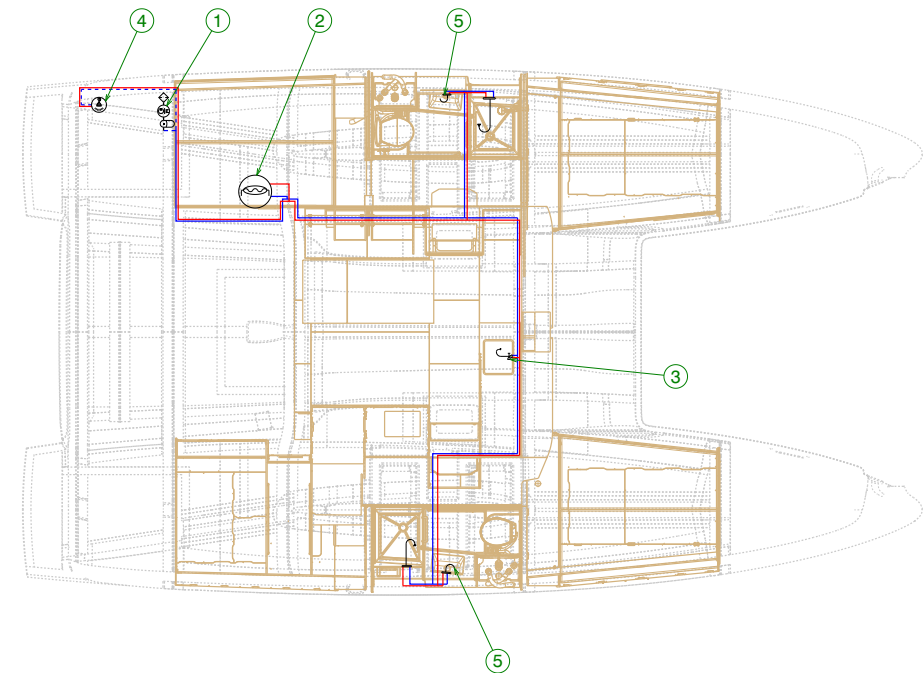

4. Cockpit shower
5. Head sink mixer tap

10.5 Water unit

General points

- It supplies all the boat's plumbed-in equipment with fresh water. It is fitted with a pressure switch that activates the flow when the pressure in the water system falls.
- The water pump is switched on at the helm station.
- Make sure that the water unit never runs dry.

Control

- When the water unit is powered by the DC circuit, the switch lights up in red.
- When the ON indicator turns green, the water unit is operating.

10.6 Blackwater system (Toilet)

- Regularly check the valves and thru-hull seacocks for proper operation and watertightness.
- Regularly check the tightness of the flexible pipe clamps and connections.

Diagram of blackwater system

3 cabins 2 heads version

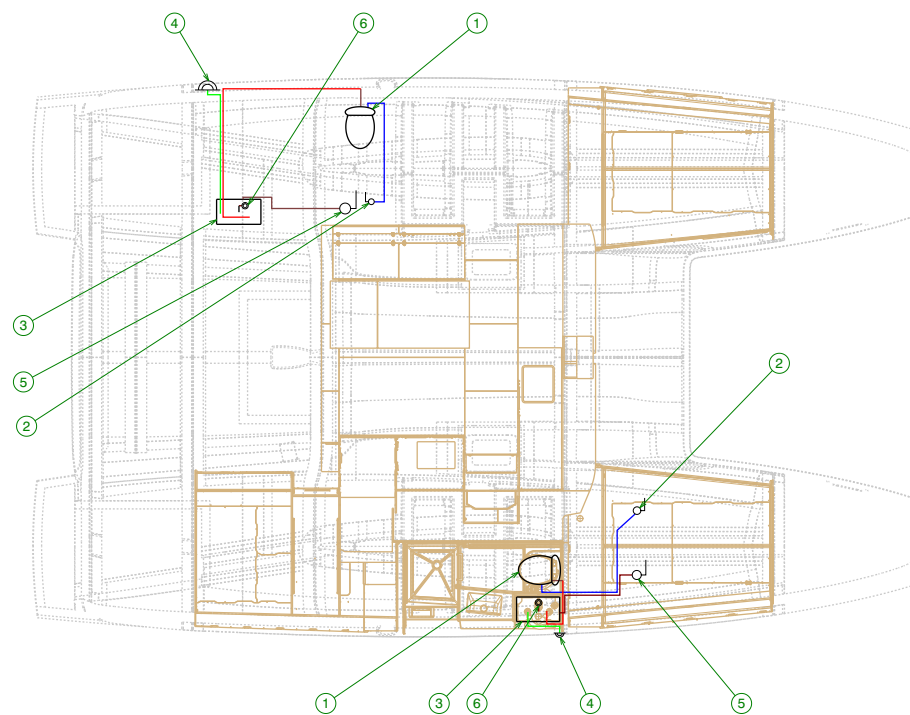

- 1. Manual toilet
- 2. Seawater intake
- 3. Black water tank

4 cabins 2 heads version

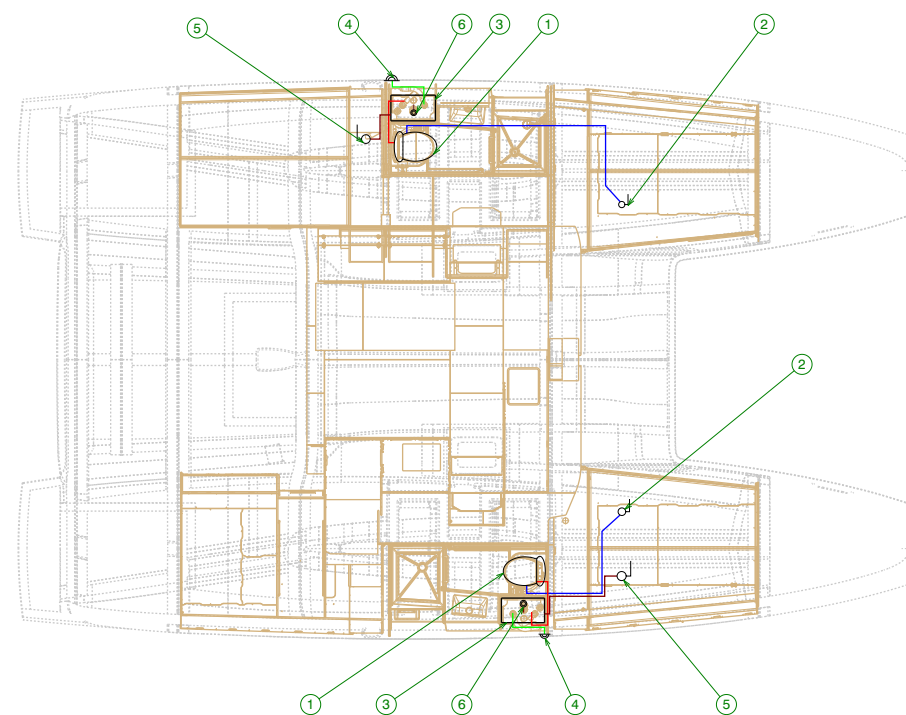

- 4. Blackwater tank vent
- 5. Drainage of blackwater tank into the sea
- 6. Black water tank drainage cap

Your boat is fitted with a blackwater tank

To minimise odours from this tank, we suggest following the use and maintenance guidelines below:

Holding tank

- A blackwater tank is used solely for the temporary collection of water from the toilets.
- The tank can be emptied in 2 ways:
 - By connection to a pumping system that empties the tank by suction. This system uses the "WASTE" deck connection.
 - Via the thru-hull fitting, which empties directly into the sea (provided that the laws of the country in which the vessel sails permit dumping into the sea).
- Only use water-soluble toilet paper to avoid blockages.

Remark

Sanitary towels and other items (paper handkerchiefs, dressings etc.) in the toilets and blackwater tank will result in blockages.

- Faecal matter causes the formation of unpleasant odours in the blackwater tanks, to which the use of salt water for flushing the toilets also contributes. Algae present in salt water also give off unpleasant odours.
- Completely empty the blackwater system before leaving the vessel unattended in temperatures below freezing.
- Ask for information about the laws in force in your country or your marina about discharging your waste waters into the sea.

Use of toilets

- Every time the toilets are used, flush afterwards with copious amounts of water in the bowl using the toilet pump (manual or electric).
- When you are leaving the boat for several days, flush with fresh water. You may wish to use the shower in the head for this purpose. Seawater allowed to stagnate in the bowl gives off bad odours.

Maintenance of blackwater tank

Advice / Recommendation

Respect local regulations regarding the emptying of blackwater tanks.

- The risk of unpleasant odours forming increases when the waste water remains in the tank for a long time.
- Whenever possible empty the tank regularly, even before it is full.
- Every time the tank is emptied put in about 5 litres of fresh water and add an appropriate detergent additive (available from chandleries). A very simple method is to add soda salts, which clean and disinfect at the same time.
- Before winterising, flush the tank with copious amounts of fresh water filling it through the 'WASTE' deck connection. Leave at least 5 litres of fresh water mixed with a detergent additive.
- Disinfecting: Disinfect the tank once a year by filling it with a solution of Javel water (1 to 1000).

Using the drainage valve



Beware of any unintentional draining.

The direct-to-sea drainage valve can be sealed by means of the drilled hole on the handle.

Emptying by gravity

Using a marine toilet fitted with a tank emptied by gravity

- I. Open the seawater intake valve.
- II. Fill the bowl by using the manual toilet pump.
- III. Using the toilet.
- IV. **a.** To empty the organic waste in the tank:
 - Make sure the draining valve is closed.
 - Empty the bowl using the manual toilet pump.
- IV. **b.** For direct discharge into the sea:
 - Open the thru-hull seacock.
 - Empty the bowl using the manual toilet pump.
- IV. **c.** To discharge through the deck:
 - Open the deck connection marked "WASTE".
 - Use the pump-out system where fitted at a port.

Using an DC electric WC fitted with a tank emptied by gravity

- I. Open the seawater intake valve.
- II. Fill the bowl by pressing the fill button.
- III. Using the toilet.
- IV. **a.** To empty the organic waste in the tank:
 - Make sure the draining valve is closed.
 - Empty the bowl by pressing the empty button.
- IV. **b.** For direct discharge into the sea:
 - Open the thru-hull seacock.
 - Empty the bowl by pressing the empty button.
- IV. **c.** To discharge through the deck:
 - Open the deck connection marked "WASTE".
 - Use the pump-out system where fitted at a port.

10 Water systems

Evacuation by the bridge

Using a marine WC fitted with a tank emptied by deck connection

- I. Open the seawater intake valve.
- II. Fill the bowl by using the manual toilet pump.
- III. Using the toilet.
- IV. a. To empty the organic waste in the tank:
 - Empty the bowl using the manual toilet pump.
- IV. b. To discharge through the deck:
 - Open the deck connection marked "WASTE".
 - Use the pump-out system where fitted at a port.

Use of a DC electric water closet

- I. Open the seawater intake valve.
- II. Fill the bowl by pressing the fill button.
- III. Using the toilet.
- IV. a. To empty the organic waste in the tank:
 - Make sure the draining valve is closed.
 - Empty the bowl by pressing the empty button.
- IV. b. For direct discharge into the sea:
 - Open the thru-hull seacock.
 - Empty the bowl by pressing the empty button.
- IV. c. To discharge through the deck:
 - Open the deck connection marked "WASTE".
 - Use the pump-out system where fitted at a port.

Using a DC electric toilet fitted with a tank emptied by deck connection

- I. Open the seawater intake valve.
- II. Fill the bowl by pressing the fill button.
- III. Using the toilet.
- IV. a. To empty the organic waste in the tank:
 - Empty the bowl by pressing the empty button.
- IV. b. To discharge through the deck:
 - Open the deck connection marked "WASTE".
 - Use the pump-out system where fitted at a port.

10.7 Waste water system

- Regularly check the valves and thru-hull seacocks for proper operation and watertightness.
- Regularly check the tightness of the flexible pipe clamps and connections.

Diagram of waste water circuit installation

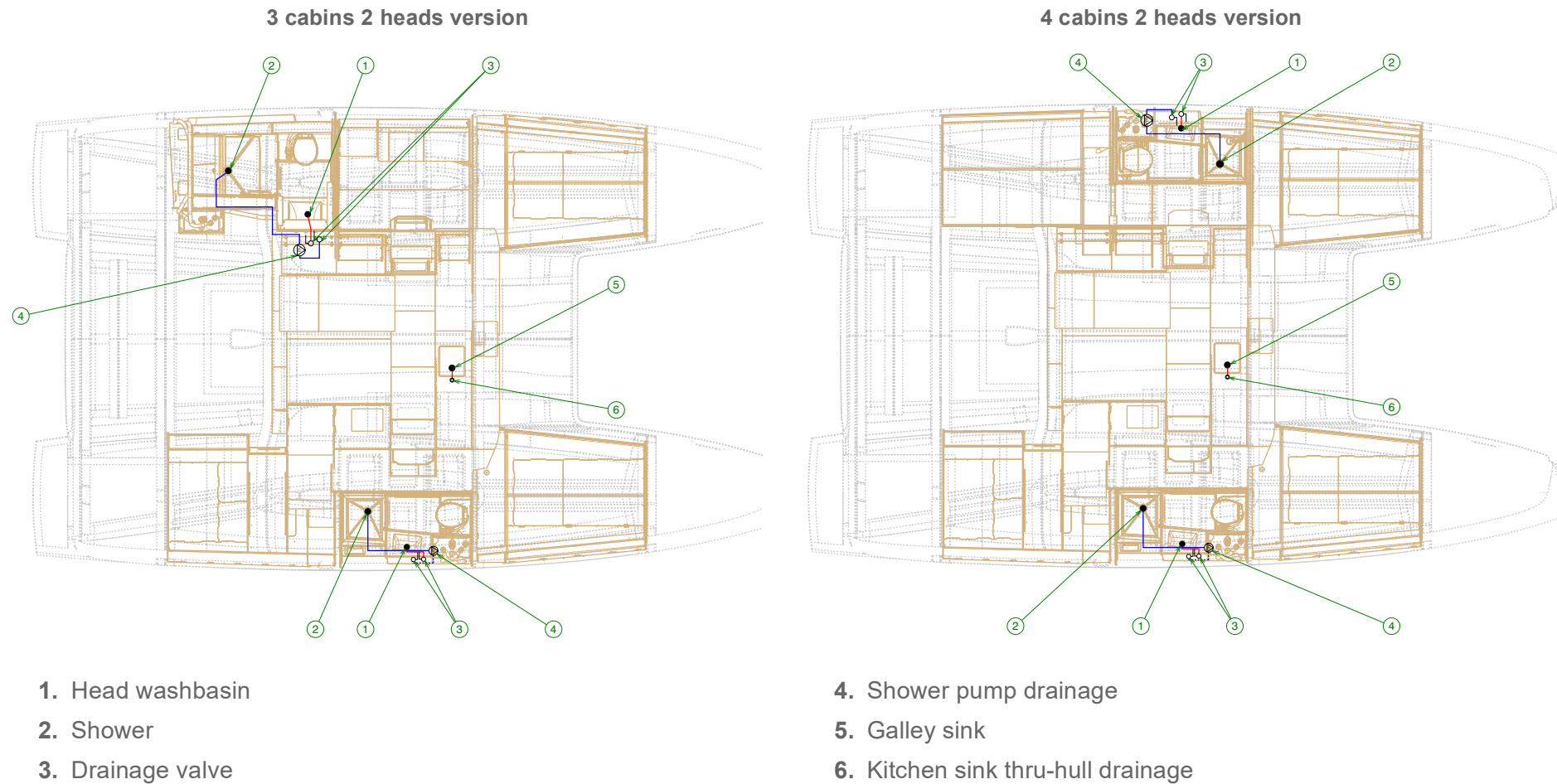

Engine

11.1 Information relating to fire risks and risks of explosion

- Make sure that the coolant is circulating properly.
- Ensure that the engine compartment ventilation air inlets are kept clear.
- Stop the engine and refrain from smoking while the fuel tank is being filled.
- Have your fuel circuit checked regularly by a professional engineer.
- Avoid any contact between inflammable materials and the hot sections of the engine.
- Never switch off or cut off energy to the electric system when the engine is running.
- Never block access to the fuel supply valve.
- Never turn the engine over when the boat is on land.
- Fuel stored outside the tanks (jerrycans, portable fuel tanks, etc.) must be stowed on deck and protected from bad weather and mechanical damage.
- Regularly check that the engine compartment is clean and dry.
- The fuel lines may become worn with age or be damaged by some impacts, pinch points or abrasion. Some lines, particularly those with a steel core, are subject to corrosion. For safety reasons, it is important to visually inspect their condition and operation at regular intervals and replace defective parts.



Never store fuel tanks or tanks containing petrol in any area not specifically designed for storing petrol.



Be aware of the risk of drowsiness due to CO with petrol or diesel engines.

11.2 Danger from moving mechanical parts

- Keep away from the drive shafts and the mechanical parts of the engine when they are in motion (including belts, moving parts and hot components).
- Be careful if you have long hair, bulky clothing, rings etc. (these may become caught).

11.3 General points

- Make sure you have enough fuel before sailing.
- Stop the engine before opening the engine compartment.
- Do not close the fuel supply valve between each use of the engine (except in the event of prolonged disuse).
- Get the whole propulsion system checked at least once a year by a professional engineer.
- Always start the engine with the control handle in neutral.
- Maintenance information for the exhaust system is described in the manufacturer's instructions.



Do not install engine(s) on this boat which are more powerful than the recommended power output, this may cause a loss of control of the boat and lead to serious injuries or death.

Advice / Recommendation

- Regularly check that the O ring on the filler cap is in good condition to prevent water ingress.
- Keep the fuel tank as full as possible to prevent condensation.
- Follow the engine manufacturer's instructions exactly.
- Never switch off the battery isolators when the boat's engine is running (risk of serious damage to the charging circuit).
- Regularly check the oil level (a gauge is provided for this on the engine).
- Regularly drain the engine according to the engine manufacturer's instructions.

11.4 Engine installation

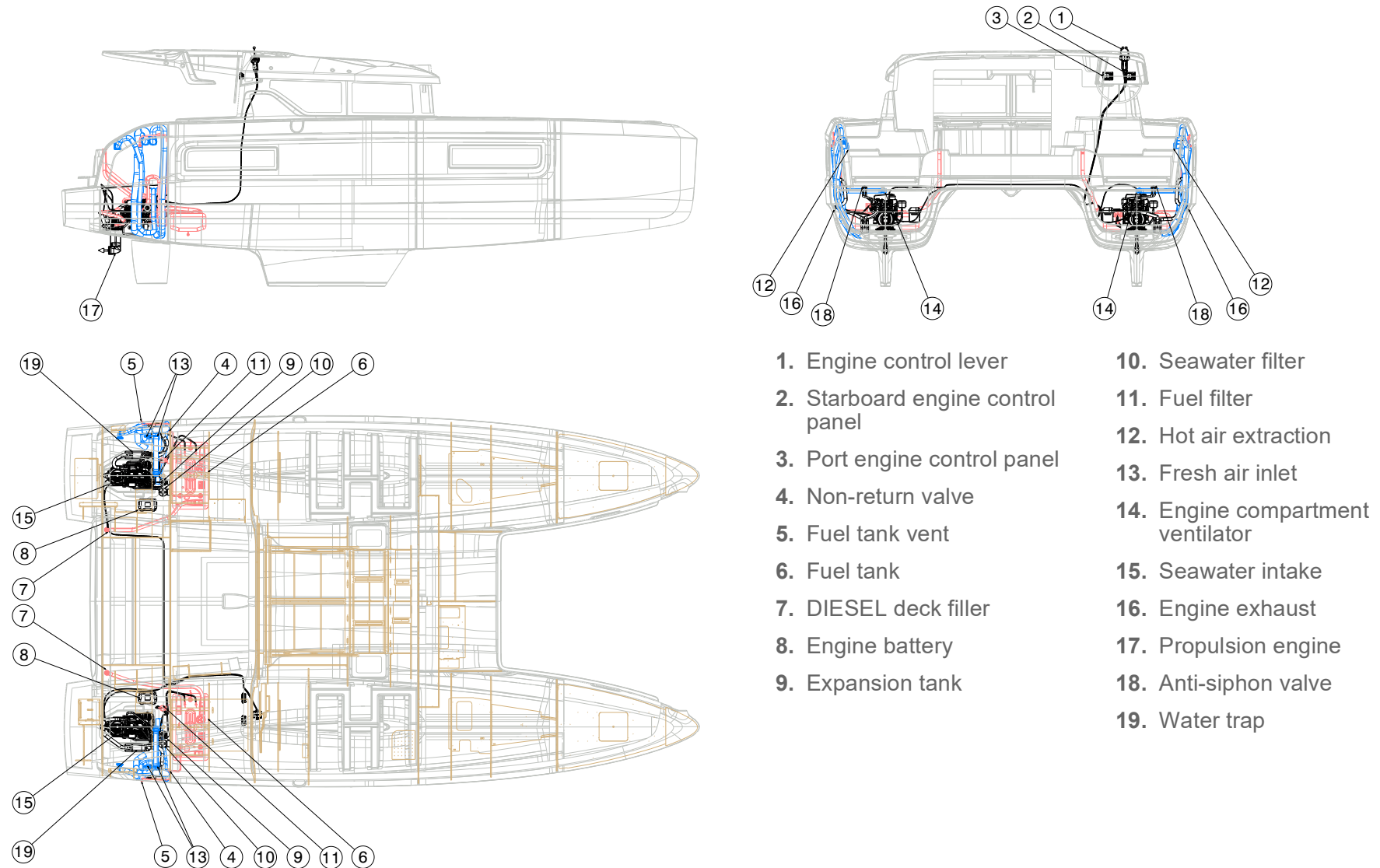

- | | |
|-----------------------------------|-----------------------------------|
| 1. Engine control lever | 10. Seawater filter |
| 2. Starboard engine control panel | 11. Fuel filter |
| 3. Port engine control panel | 12. Hot air extraction |
| 4. Non-return valve | 13. Fresh air inlet |
| 5. Fuel tank vent | 14. Engine compartment ventilator |
| 6. Fuel tank | 15. Seawater intake |
| 7. DIESEL deck filler | 16. Engine exhaust |
| 8. Engine battery | 17. Propulsion engine |
| 9. Expansion tank | 18. Anti-siphon valve |
| | 19. Water trap |

11.5 Starting the engine

- Check the coolant flow.
- The bilge fan of the engine compartment is automatically switched on as soon as the engine is contacted.



Learn how to judge the necessary distance of deceleration for the vessel to come to a complete stop (the reverse gear is not a brake).



Information about the propulsion inverter are contained in the manufacturer's documentation.

11.6 Propeller

- Propeller efficiency will drop if the propeller blades are damaged or dirty: clean the blades regularly and attentively.
- During lift-out, check the propeller: it should turn freely on its axis and there should be no play.



If this boat is equipped with a fixed blade propeller, when sailing at speeds over 8 knots it is essential to leave the reverse gear control in neutral.

11.7 Fuel-burning equipment for purposes other than propulsion (Generator)

- Make sure that the ventilation openings in the engine (and, if installed, generator) compartment are well-cleared.
- Stop the engine and refrain from smoking while the fuel tank is being filled.
- Have your fuel circuit checked regularly by a professional engineer.
- Avoid any contact between inflammable materials and the hot sections of the engine.
- Take all necessary precautions to avoid contact with naked flames and other hot areas.
- Do not obstruct or modify the ventilation system.
- Fuel stored outside the tanks (jerrycans, portable fuel tanks, etc.) must be stowed on deck and protected from bad weather and mechanical damage.

11.7.1 Generator



- Never start the generator when the air conditioning is already on. Always turn off the air conditioning before turning off the generator.
- Never connect the shore power to the generator: you may suffer an electric shock.
- An extinguisher access port is provided on the generator in the event of a fire starting in the generator.

Starting up

- Make sure that the ventilator in the generator compartment is working.
- Fill the generator with water to prevent the seawater pump from running dry (refer to the supplier's recommendations).
- Open the raw water intake valves and evacuation valves.
- Open the fuel supply valve.
- Turn the generator's battery switch to the ON position.
- Switch the generator's circuit-breaker to the ON position.
- Turn on the generator using the remote control (located near the main switch panel) or on the generator itself.
- Make sure that no AC equipment is running. Toggle the shore power/generator switch.

In the event of the generator catching fire

- Do not open the generator.
- Cut the power supply (electrical and fuel) to the boat's engines, to the generator and to the ventilators.
- Use the extinguisher access port on the generator to discharge the contents of the portable extinguisher.

Steering system

12.1 General points

- The steering system is an important safety feature. For this reason, an annual inspection of the whole system must be carried out by a professional engineer.
- Owners are expected to operate the boat in a reasonable manner, with the direction of the helm (in degrees/seconds) set according to the actual speed of the boat.
- Regularly check the tension of the steering cables and the tightness of the steering components. If needed, adjust the tension of the steering cables. Don't tighten the steering cables excessively. When properly adjusted the steering should work smoothly, with no play at all and no stiffness in the tiller or wheel (consult your dealer).
- Regularly grease the chains and pinions.
- Do not grease the steering cables or the pulleys.
- Maintain the nylon, ertalon or teflon bushes with only a suitable lubricant.
- Each ring is a wearing part: make sure you change them regularly (Please contact your dealer).

Advice / Recommendation

Greasing the steering bearings creates a risk of them seizing with dust and no longer working properly.

12.2 Diagram of layout

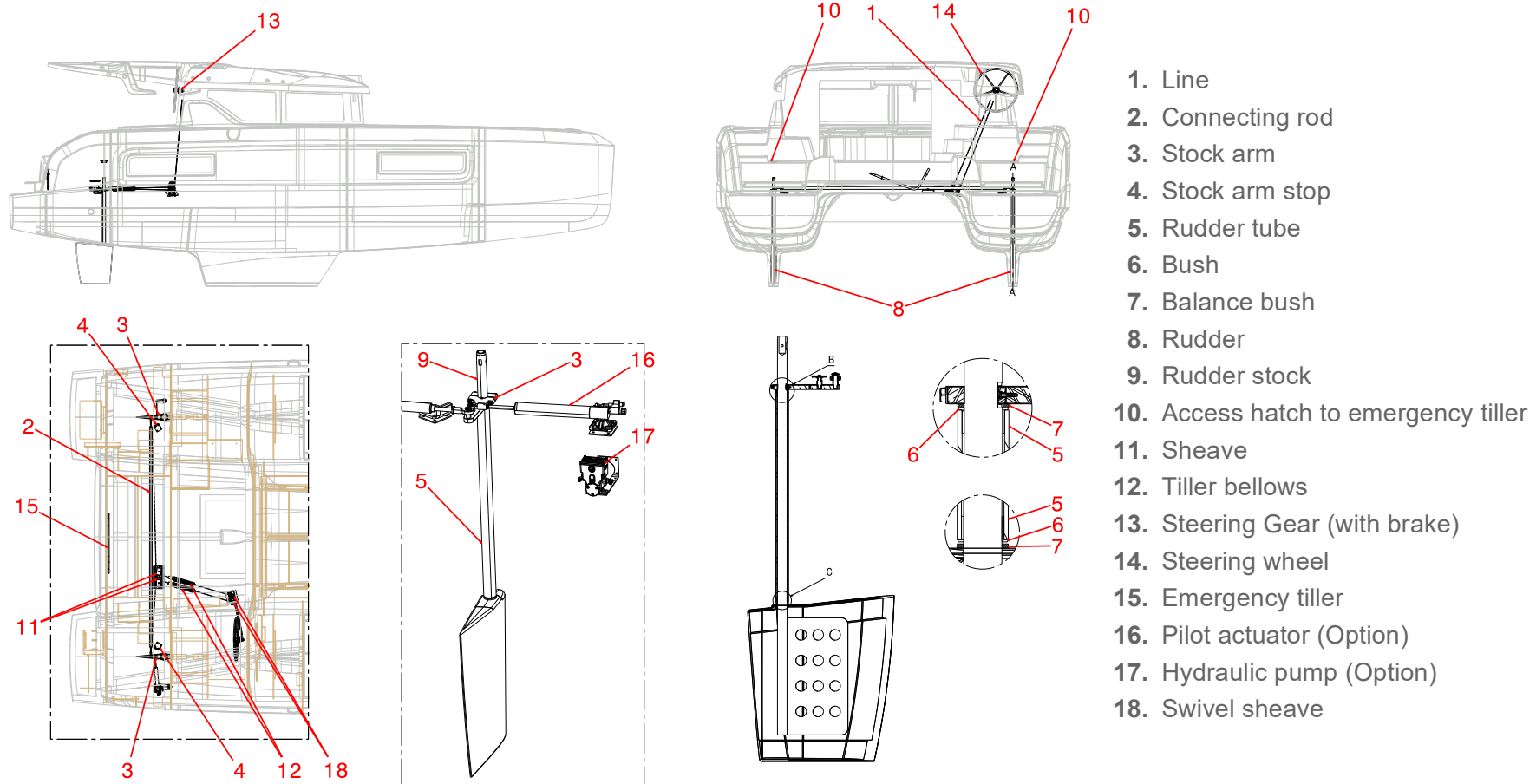

Deck fittings

13.1 Equipment

13.1.1 Davits

- The davits enable the launch and retrieval of the tender from the transom. Any other use is dangerous and must be strictly avoided.
- The davits are equipped with a pulley block for manoeuvring the tender. This pulley block is manoeuvred by hand/using an electric winch.
- A breaker protects the electrical circuit.

Launching the tender

- Insert the bung.
- Secure the pulley's hooks to the front and back of the tender.
- Lower the front then the back of the tender alternately until it touches the water.

Retrieving the tender from the water

- Pull out the bung.
- Secure the pulley's hooks to the front and back of the tender.
- Raise the front and then the back of the tender alternately as high as the pulley block allows.



No one must be onboard the tender while launching or retrieving it.



The davits are designed to support a maximum load of 150kg and a tender which is at most 2,90m long.

Advice / Recommendation

- Before heading out to sea, remove the outboard engine from the tender and store it on the boat.
- Secure the tender taking account of sea conditions.
- Secure the outboard engine to the tender once this is in the water.

13.2 Anchoring, mooring, towing

13.2.1 Anchor points



Anchoring points showing visible signs of deterioration must be replaced.

Responsibility

It is the responsibility of the owner/user of the boat to ensure that the berthing lines, towing cables, chains and mooring lines and the anchors are adequate for the intended use of the boat, i.e. that the lines or chains do not exceed 80 % of the breaking strength of the corresponding anchor point.

	Aft mooring	Forward mooring	Mooring & Towing
Reference (<i>Diagram on next page</i>)	1	2	3
Anchor Point Breaking Strength	37,9kN	54,3kN	54,3kN
Mooring Line/Chain Breaking Strength	30,3kN	43,4kN	43,4kN

Fenders

- Be sure to protect the transom platform with a fender to avoid friction with the pontoon.
- Use a sufficient number of fenders (boat fenders) to protect the boat from any risk of rubbing against the pontoon/quay.

Location of attachment points

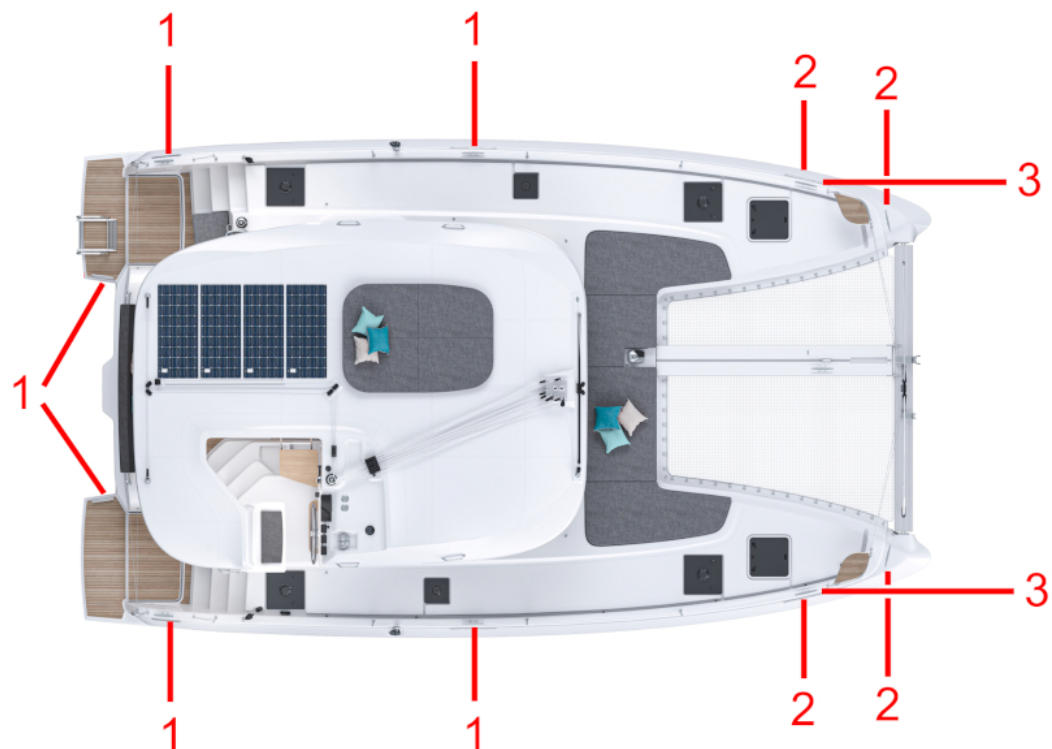

1. Aft and middle mooring cleat
2. Forward mooring cleat
3. Anchoring and towing cleats

13 Deck fittings

13.2.2 Mooring

In order to relieve the pressure on the windlass, preventing the chain from pulling upwards and potentially damaging it, it is necessary to transfer the stress using a clamp which attaches to the chain and is connect using a line to the mooring and towing cleat of the previous diagram (Reference 3).

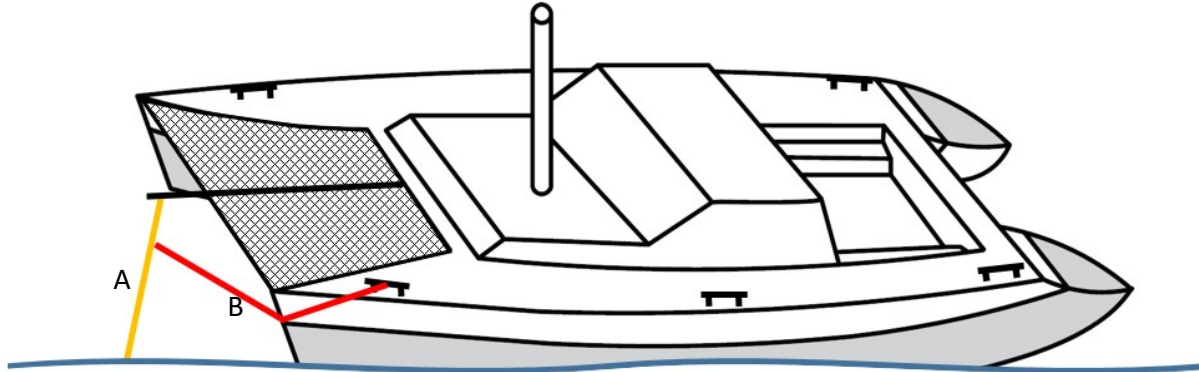

- The mooring line (A) should be attached to an anchoring point.
- The breaking strength of the line/chain (B) used to attach the mooring line should not exceed 80% of the breaking strength of the corresponding anchoring point, consider splitting the strength if multiple lines/chains are used or if the line/chain is doubled.

13.2.3 Towing



- Generally the breaking strength of lines/chains must not exceed 80% of the breaking strength of the anchor points.
- Always tow or be towed at low speed. Never exceed the maximum speed of a displacement hull during a tow.
- Be particularly vigilant when the end of a towing cable is being thrown or received (the end may become caught in the propeller).
- A towing cable must always be secured in such a way that it can be released under load.
- Do not try to stop the boat by using a boathook or your foot, hand or any other part of your body.

Responsibility: It is important that the owner thinks through the actions required when securing a towing cable onboard.

13.3 Electric windlass

The windlass is designed for anchoring purposes: Any other use is dangerous and must be strictly avoided.

Operation



The handle serves only to release the chain sprocket in order to lower the anchor manually should the electric windlass break down. The handle cannot be used to raise the anchor manually.

Maintenance

- Once a year, dismantle, carefully wash and grease all the moving parts of the windlass.
- Regularly grease the supply terminals of the electric motor of the windlass and of the relay control box.



- Windlass operations are dangerous:
 - Always keep the anchor chain or rope free and unfouled;
 - Carry out manoeuvres carefully and always wear shoes;
 - Avoid wearing baggy clothing and jewellery that could get caught in the engine when it is running. Tie up long hair..

Emergency anchoring procedure

Advice / Recommendation

- Before anchoring check the depth of water, the power of the current and the nature of the sea bed.
- Check the swing radius once the boat is at anchor.
- After each trip rinse the windlass and anchor chain or rope with fresh water.

In the event of an electrical fault, it is possible to lower the anchor manually: Put the handle in the space provided to release the chain sprocket. Let the chain run out using the handle to control the speed as it runs.

13.4 Tender



The portable fuel tank for the tender must be stored on the deck.

Handling and transport

14.1 Position of straps

The position of the lifting slings is shown in the pictogram below:



14.2 Lifting

- **Before applying antifouling NEVER:**
 - Do any sandblasting;
 - Use any other solvents than ethylic alcohol;
 - Use pressure washer detergents;
 - Use scrapers;
 - Use grinding tools.
- Before the first application of antifouling to the hull, you should lightly sand the hull using wet and dry sandpaper of 400 µm or more.
- The lower hull of your boat should be covered with an anti-fouling paint to prevent the adhesion of marine growth.
- The water quality where your boat is kept, along with the frequency of lifting, will determine the choice of antifouling.
- All bronze or steel surfaces, including the propellers, should be protected by a suitable antifoul paint.
- During the lift-out, check the anodes and the propeller (see corresponding chapters).
- Antifouling can deteriorate when the boat is ashore or dried out: Please observe the out-of-water time limit set by the supplier.
- If cleaning off existing antifouling requires high pressure washing:
 - Ensure the water temperature does not exceed 15 degrees;
 - The water pressure must not exceed 150 bar (2175 PSI);
 - The distance between the hose nozzle and the hull must not be less than 10 centimetres.

14.3 Launching and retrieving

The first time you use your boat a high level of skill and attention will be required. The proper functioning of all equipment will depend on the initial set-up being carried out correctly. For this reason the first launch must be carried out under your dealer's supervision.

Before launching

- Replace the speedometer in its housing.
- Check the cleanliness of the seawater filters.
- Check the anodes (see Chapter: ELECTRICAL SYSTEM).
- Check the propeller (see Chapter: STEERING SYSTEM).
- Prepare enough fenders and lines.
- Check the engine's seawater intake valve and the fuel feed valve (see Chapter: ENGINE).



Do not stand onboard or beneath the boat during the handling operations.



- When placing the slings make sure that the positioning marks are still visible.
- Immerse the sling fully under the engine mounting.

14.4 Stepping and unstepping the mast

The stepping/unstepping operations require the skills of a professional rigger: please consult your dealer.

14.5 Winterisation

Advice / Recommendation

- Engine winterisation requires a professional engineer: please consult your dealer.
- This is not an exhaustive list of recommendations: Your dealer will give you the advice you need and will carry out technical maintenance of your boat.

Environment







Waste management



- Make sure you know the local environmental regulations and follow the codes of best practice.
 - Do not pump out the toilets or the contents of the black water tank near the coast or in areas where this is forbidden. Use the pump-out facilities available in ports or marinas to empty the contents of the black water tank before leaving port.
 - Make sure you know the international regulations to prevent pollution in the marine environment (MARPOL Convention) and follow these as much as possible.
-
- Throw all packaging in the recycling containers provided.
 - Once a piece of equipment has stopped working completely, find out about the relevant recycling regulations from your nearest recycling centre or from your dealer.
 - Make sure you follow the relevant local laws when scrapping.
 - Some onboard equipment can have a toxic effect on the environment and on human health due to the specific substances they contain: Do not throw any equipment in household waste containers and absolutely never dispose of equipment in the sea.
 - Dead batteries are toxic to health and to the environment. Batteries must not be put in with household waste and must be recycled separately. Contact the harbour master or a specialist company about recycling them.

Appendix

Label key

					
Engine group	Plumbing group	Colour – WC group	General electrical equipment	Comfort group	Drainage group



Valve location label

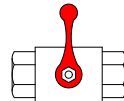



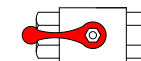





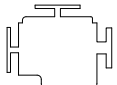



Closed valve





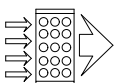







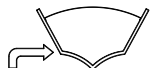

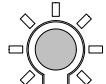

Open valve

Meaning of the symbols

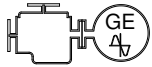
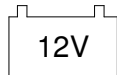
	Motor		Shower		Electronic pump
	Port engine		Washbasin		Manual pump
	Starboard engine		Ice maker		Toilet
	Propeller shaft		Deck wash		Washer
	Filter		Sea water tap		Dryer

Appendix

	Hull drainage		Waste water tank		Dishwasher
	Sea water intake		Fresh water tank		Watermaker
	Shore power socket		Fuel tank		Fuel filter
	Service		Holding tank		Inverter
	Generator		Battery stock		Heating
	Breaker		Thruster		Air conditioning

Each label is defined by:

- a functional group (specific colour);
- a component.

example:

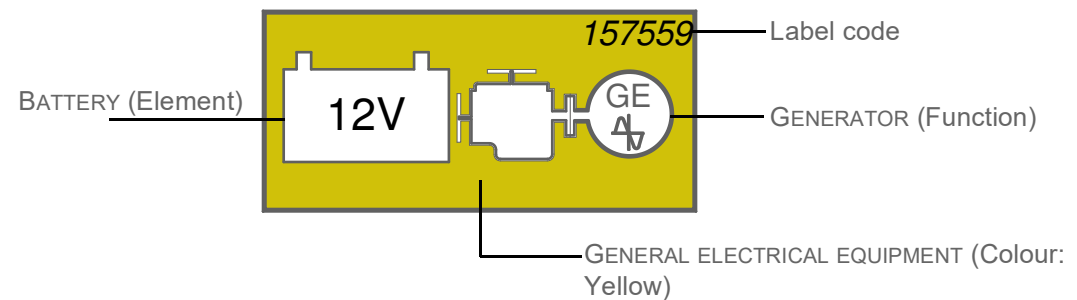



ENGLISH

CE 259744 RCD-2
Index B